

NATIONAL ENVELOPE AND WILLIAMHOUSE

ARE PLEASED TO BRING YOU THIS

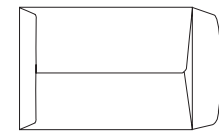

COMPREHENSIVE, FUNCTIONALLY ORGANIZED

ENVELOPE GUIDE WHICH INCLUDES:

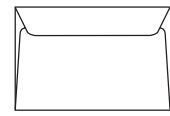

- Divided sections to help you locate the information you need;

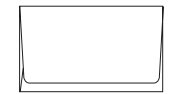

- Envelope style and size charts;

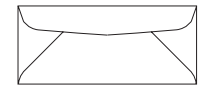

- Important information relating to the functional uses of envelopes;

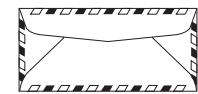

- Updated postal information & fold-out envelope mailability template;

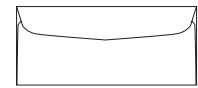

- Printing information;



- Sealing methods / flap styles / seam styles;

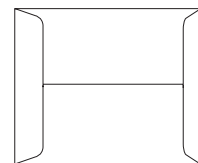

- And much more!

NATIONAL ENVELOPE CORPORATION HISTORICAL OVERVIEW

- 1952** Founded by William Ungar as New York Envelope Company. Since the company's inception, Mr. Ungar has been the Chairman, President and Chief Executive Officer. National Envelope Corporation has been family owned and operated since 1952 when it began as a company with 3 machines and 5 employees.
- 1970-PRESENT** Expansion by organizing and acquiring 8 envelope manufacturing companies. Two of those eight companies were newly organized companies... In 1970, National Envelope Corporation-North and in 1975, with the purchase of machinery at a bankruptcy sale in Georgia, National Envelope Corporation-South. Today, NATIONAL ENVELOPE CORPORATION has grown to seventeen envelope manufacturing facilities in twelve states.

Acquisitions by Date and Location

1952 - New York Envelope New York	1990 - Aristocrat Envelope New York
1970 - National Envelope - North Massachusetts	1994 - Old Colony Envelope Massachusetts
1975 - National Envelope - South Georgia	1995 - National Envelope - Northwest Washington
1980 - National Envelope - Midwest Kansas	1998 - Colortree Texas
1981 - Champion Envelope New Jersey	2000 - Williamhouse Corporation Texas
1981 - National Envelope - Central Missouri	2001 - Alcor Envelope New York
1990 - Champion Envelope - West California	

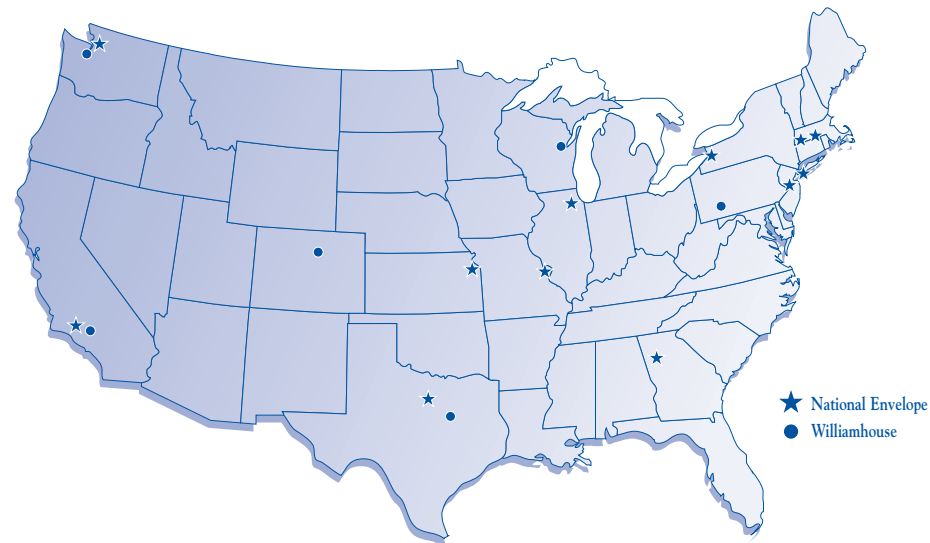

Plant Locations

New York Envelope Long Island City, New York	Williamhouse - Pennsylvania Scottdale, Pennsylvania	Williamhouse - Wisconsin Appleton, Wisconsin	National Envelope - West Chino, California
Old Colony Envelope Westfield, Massachusetts	National Envelope - South Austell, Georgia	Williamhouse - Texas Corsicana, Texas	Williamhouse - Northwest Kent, Washington
Old Colony Envelope Hamburg, New York	National Envelope - Midwest Lenexa, Kansas	National Envelope - Texas Grand Prairie, Texas	National Envelope - Northwest Kent, Washington
National Envelope - North Worcester, Massachusetts	National Envelope - Central Earth City, Missouri	Williamhouse - Colorado Aurora, Colorado	
National Envelope - East Union, New Jersey	National Envelope - Great Lakes Elk Grove Village, Illinois	Williamhouse - California City of Industry, California	

NATIONAL AND WILLIAMHOUSE

- ☒ Over 50 years of expertise serving the envelope community.
- ☒ Strongly committed to quality and service.
- ☒ Quality envelopes are your assurance of product satisfaction.
- ☒ Reliable products with exceptional service at competitive prices.
- ☒ Professional Sales & Customer Service Representatives ready to assist you with all your envelope requirements.
- ☒ Quality envelopes converted from the broad offerings of these distinguished mills:

- Appleton
- Badger
- Boise Cascade
- Cascades
- CTI
- Curious Papers
- Curtis Fine Papers
- Domtar
- DuPont Tyvek®
- Eastern Paper
- Finch Paper
- Fox River Paper
- French Paper
- Gilbert Paper
- International Paper
- Beckett
- BriteHue
- Strathmore
- Via
- Mohawk
- Monadnock
- Neenah
- Smart Papers
- Wausau Paper
- Weston
- Weyerhaeuser Paper
- Whiting, G.A.

and many others...

NATIONAL SAMPLE DEPARTMENT

800-448-3463

WILLIAMHOUSE SAMPLE DEPARTMENT

800-655-4366

For more company information visit us on the web at:
www.nationalenvelope.com and www.williamhouse.com



WILLIAMHOUSE®

Copyright© 2003 by National Envelope Corporation

HOW TO USE YOUR NATIONAL / WILLIAMHOUSE ENVELOPE SPECIFIER™

This tool is easier to use than ever before. To save you time, we have divided the book into six sections to help you quickly find the specific information you need.

SECTION A. ENVELOPE BASICS – Pages 5-14

Practical envelope terminology, construction and recommended papers.

SECTION B. ENVELOPE STYLES – Pages 15-34

An illustrated guide to aid in the selection of the most appropriate envelope.

SECTION C. ENHANCEMENTS – Pages 35-42

General information on envelope printing, and other embellishment processes.

SECTION D. QUALITY ENVELOPES – Pages 43-46

What should you look for in a quality envelope?

SECTION E. POSTAL REQUIREMENTS – Pages 47-52

Understanding and complying with selected Postal Service requirements.

SECTION F. GLOSSARY & INDEX – Pages 53-62

A guide to relevant envelope-related terminology for easy cross-reference.

ENVELOPE BASICS

In this section you will find:

- Envelope Manufacturing Steps
- Envelope Construction
- Dimensions & Designations
- Flap Styles
- Seam Styles
- Sealing Methods & Closure Devices
- Window Envelopes
- Types of Papers Used

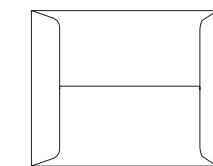
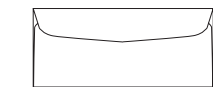
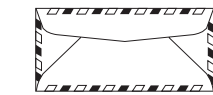
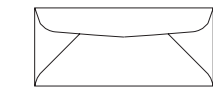
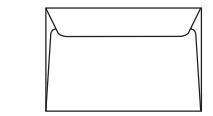
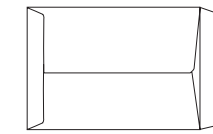
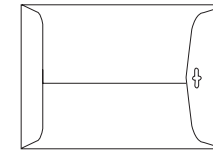

ENVELOPE BASICS

ENVELOPE BASICS

BASIC DIE CUT ENVELOPE MANUFACTURING STEPS

We start with paper...

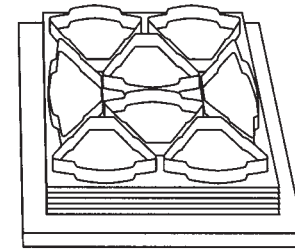
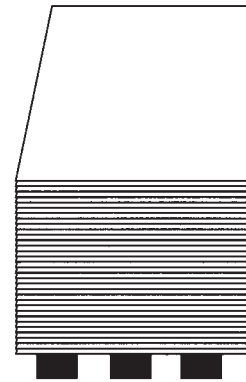
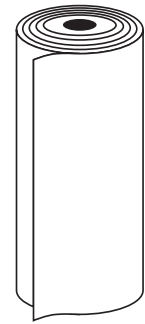

which is die cut into blanks.

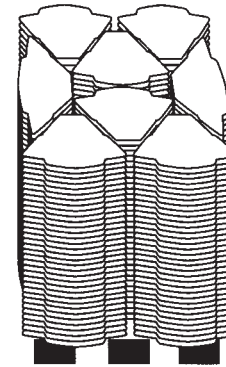

The blanks are fed into an envelope machine which scores, folds and applies adhesives...

and produces the finished product!

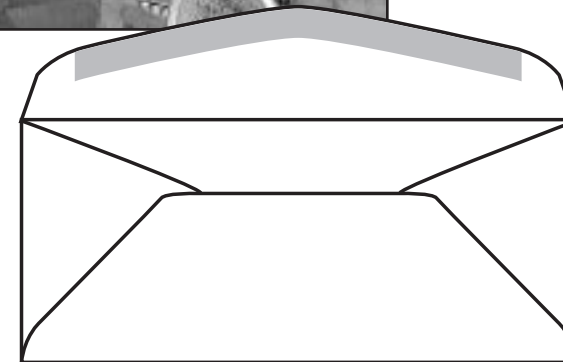

ENVELOPE DIE CUTTING

Properly manufactured commercial envelopes perform well on printing and inserting equipment with either Straight or Diagonal Grain construction.

Straight Grain Cutting

Straight Grain cutting from a 34" x 28" Sheet of Bond or Writing Paper yields eight No. 10 commercial envelopes.

It is our policy that envelopes created from directional paper, are Straight Grain cut; however, envelopes marked (A) are grain parallel to the 9 1/2" length while those marked (B) are grain parallel to the 4 1/8" length. If the grain direction runs the 34" way this ratio is reversed.

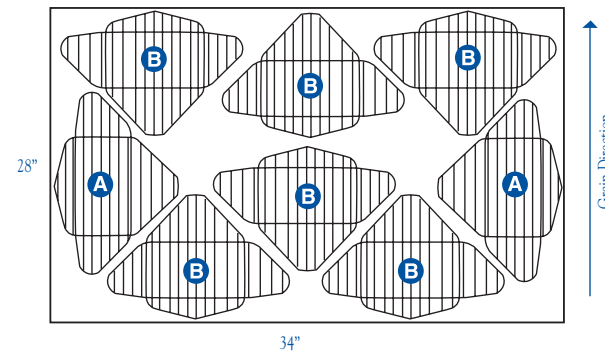
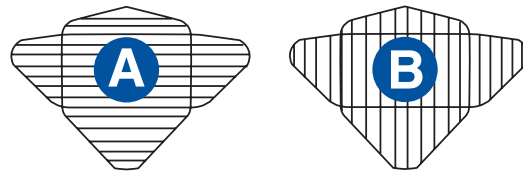

Diagonal Grain Cutting

Diagonal Grain cutting from a 17" x 22" Sheet of Bond or Writing Paper yields five No. 6 3/4" commercial envelopes. In diagonal cutting the grain runs in a diagonal direction on the blank and finished envelope.

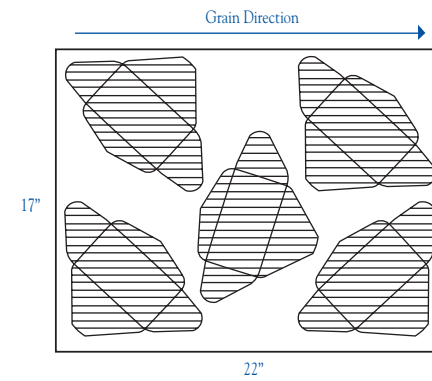
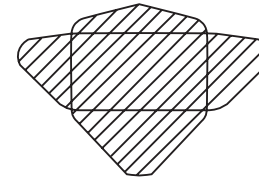

Number of Envelope Cut Outs from Frequently Used Standard Bond, Writing and Text Paper Sizes

Sheet Size	6 3/4*	Monarch*	No. 10*	A-2**	A-6**	A-7**	9 x 12 Booklet**
17 x 22	5	4	3	-	-	-	-
22 x 34	11	8	6	9	8	6	-
23 x 35	11	8	7	10	8	6	2
24 x 38	13	9	8	-	-	-	-
25 x 38	13	10	8	12	10	8	2
28 x 34	14	10	8	11	10	8	-

* OSDS (Diagonal Seam) Cross Grain. ** Straight Grain.

To calculate the envelope weight from a sheet size, divide the number of envelopes cut from a given size into the sheet weight per M.

EXAMPLE: A sheet size 22 x 34, Sub 24 weighs 96 Lbs. per thousand sheets (expressed as 96M). The chart tells you sheet size 22 x 34 yields six No. 10 size envelopes. Dividing 6 into 96M equals 16Lbs. which is the number of pounds of paper used to make 1M No. 10 envelopes cut from this size and substance before waste.

ENVELOPE CONSTRUCTION

Envelopes can be manufactured in an almost endless number of sizes and shapes. However, almost all envelopes stem from two basic construction designs; they are either **open side** or **open end**. Dozens of different designs can be developed from these two basic styles to meet the customer's particular requirements. Imagination and creativity are extremely important parts of the envelope industry.

DIMENSIONS AND DESIGNATIONS

Sizes are listed in inches, the shortest dimension first. Designations depend, in part, on the location of the opening and the seal flap. It is important to specify how the envelope should open for aesthetic reasons as well as for functional considerations.

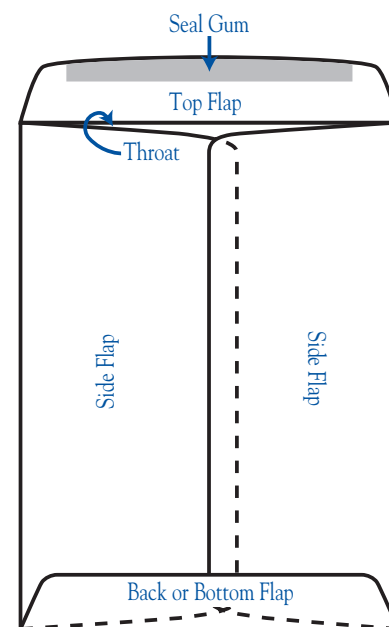

Open End

This is an Open End (OE) envelope. The opening and the seal flap are located on the short dimension. Open End envelopes are well-suited to hand insertion applications. Larger, Open End envelopes are also called "Catalogs". A 9 x 12" open end has its flap on the 9-inch dimension.

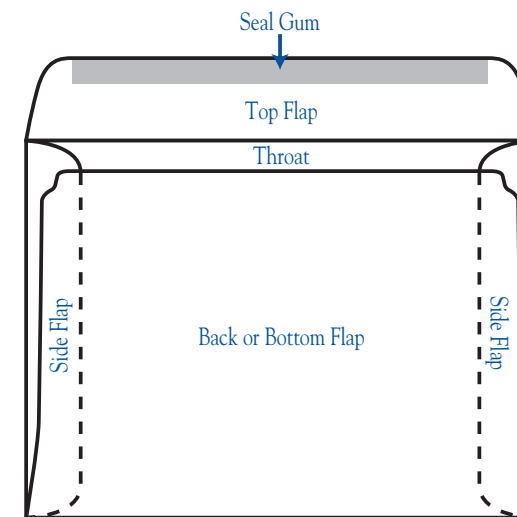

Open Side

This is an Open Side (OS) envelope. The opening and the seal flap are located on the long dimension. Open Side envelopes are ideal for automatic insertion applications and are suited for hand insertion applications as well. Larger, Open Side envelopes are also called "Booklets". A 9 x 12" open side has its flap on the 12-inch dimension.

ENVELOPE CONSTRUCTION

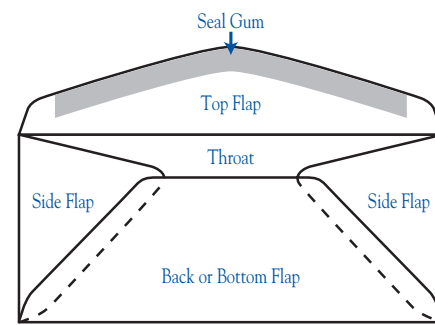

Commercial Flap, Diagonal Seam

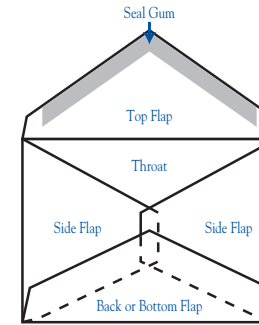

Baronial Style

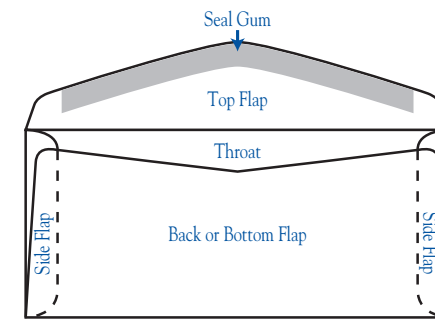

Commercial Flap, Side Seam

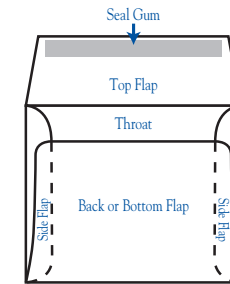

A-Style Announcement

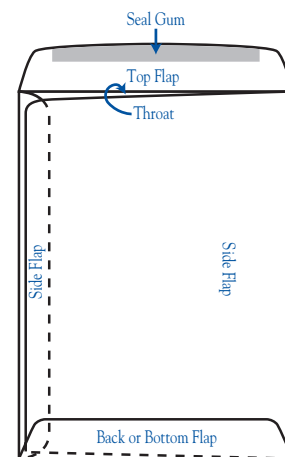

**Open End,
Single Side Seam**

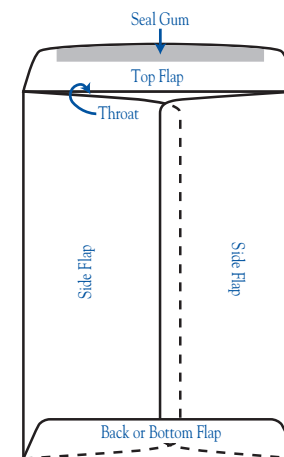

**Open End,
Center Seam**

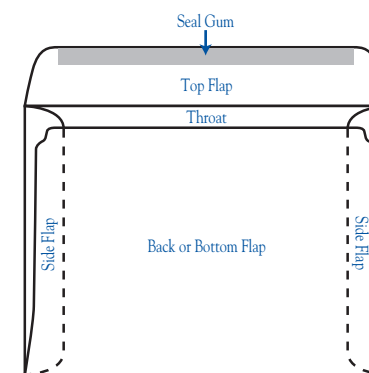

Booklet

SEAM STYLES

Seams also determine envelope style and functional application.

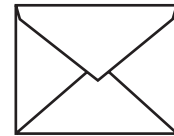

Diagonal Seams

Commonly used in correspondence commercials and pointed flap announcements. This seam style is a workhorse and generally well-suited for applications involving mechanical insertion equipment, laser printing and postal meters.

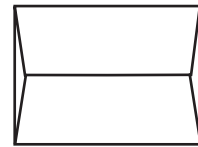

Side Seams

These seams allow for a large, uninterrupted printing area on both front and back of the envelope. Mostly found on booklets, square flap and side seam commercial envelopes. Commercial sizes are suitable for some laser and inserting applications; others should be tested first.

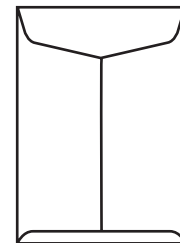

Center Seams

This seam is located in the center of the envelope, adding strength for carrying heavy inserts to its design. Envelopes with a center seam generally are not suitable for automatic insertion equipment or postage meter applications. Testing is suggested before use in laser printers.

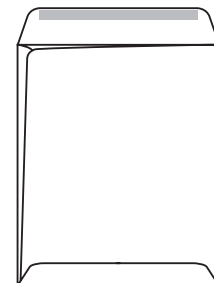

Single Side Seam

Seam is placed parallel to the edge of the envelope. Usually found in open end style envelopes (with or without flap). The full-sized side flap allows a larger printing area unobstructed by seams or multiple paper thicknesses. Manual insertion is recommended for this style.

FLAP STYLES

The seal flap is the part of the envelope folded over and sealed to secure the contents. The shape of the seal flap is very important in the determination of the envelope's style and functionality.

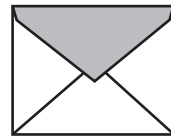

Pointed

Elegant, traditional, and more formal. Used primarily on Baronial, greeting card and social stationery envelopes. Not recommended for laser or inserting equipment applications.

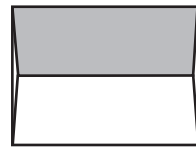

Square

Provides large area for design on flap and has contemporary appearance. May have deckle edge. The lack of a shoulder in this flap can create problems during automatic insertion. Standard No. 10 sizes are suitable for laser printing applications, while others sizes may present difficulties.



Wallet

Similar to a square flap, but with round corners. Standard flap on most booklet, catalog and specialty commercial envelopes. Flap style enables secure closure of bulky contents and is functional for automatic inserting, mailing and laser equipment processing.

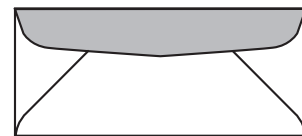

Commercial

Standard flap on correspondence-style envelopes for business and commercial use. Quality commercial envelopes have full-cut commercial style flaps. These flaps are designed to reduce make-ready for corner card printing, improve sealing when bulky inserts are used, and enhance inserting and laser printing performance.

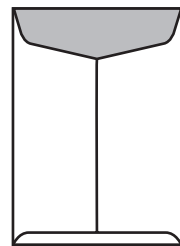

Mailpoint

Originally designed to enable volume mailings to run on automatic equipment, the mailpoint flap, normally found on open end (catalog) envelopes, is being replaced by the more modern wallet flap.

SEALING METHODS AND CLOSURE DEVICES

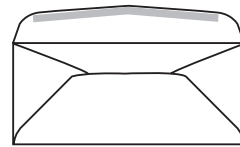

Remoistenable Seal Gum

Activated by moistening when flap is to be sealed.

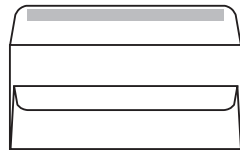

Simple-Seal®

Self-adhering latex adhesive on two surfaces that seal on contact without moisture. The unique folded flap feature on stationery envelopes keeps the two latex flaps separate until sealing is desired.

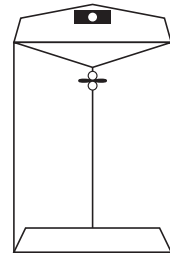

Clasp

Double-pronged metal clasp for added security. Envelopes with this closure treatment cannot be run through graphic or other automatic processes after conversion.

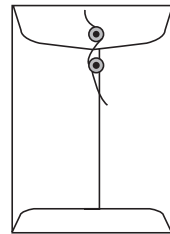

String & Button

Tie-down closure for repeated use. Envelopes with this closure treatment cannot be run through graphic and other automated processes after conversion.

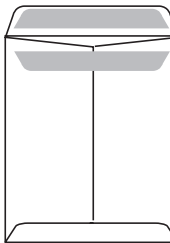

Latex Seal

Self-adhering latex adhesive on two surfaces that seal on contact without moisture. Flaps are extended and adhesive is exposed. Envelopes with this closure are not recommended for automatic insertion or laser applications.

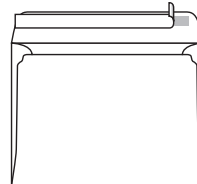

Peel & Seal®

A release tape liner is applied over a resin adhesive. When the liner is removed and the flap is pressed down, it seals on contact without moisture. Printing after the envelope is folded can be accomplished without interfering with the quality of the seal.

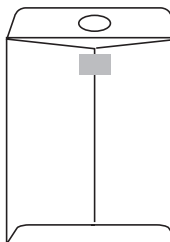

Tac -n- Tac®

A Tac-n-Tac seal tape closure allows reusable sealing of flap. Envelopes can be printed after folding.

WINDOW ENVELOPES

Modern window envelopes may be used for a variety of applications. Standard windows are rectangular with slightly rounded corners. Special window sizes and styles are also available.

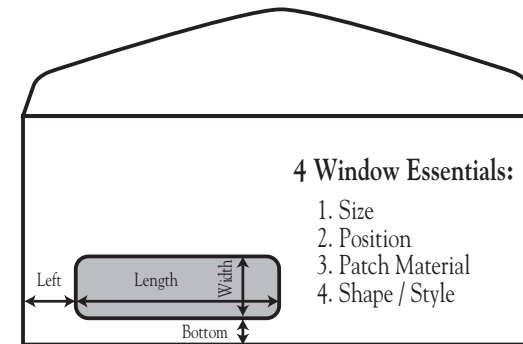

Item	Size	Standard Window Size	Position From	
			Left	Bottom
6 1/4	3 1/2 x 6	1 1/8 x 4 1/2	3/4	1/2
6 3/4	3 5/8 x 6 1/2	1 1/8 x 4 1/2	7/8	1/2
7	3 3/4 x 6 3/4	1 1/8 x 4 1/2	7/8	1/2
Monarch	3 7/8 x 7 1/2	1 1/8 x 4 1/2	7/8	1/2
7 3/4	3 7/8 x 7 1/2	1 1/8 x 4 1/2	7/8	1/2
8 5/8 Check	3 5/8 x 8 5/8	1 x 4	1	3/4
9	3 7/8 x 8 7/8	1 1/8 x 4 1/2	7/8	1/2
10	4 1/8 x 9 1/2	1 1/8 x 4 1/2	7/8	1/2
FASTforward® 10	4 1/8 x 9 1/2	1 1/8 x 4 1/2	7/8	5/8
11	4 1/2 x 10 3/8	1 1/8 x 4 1/2	7/8	1/2
12	4 3/4 x 11	1 1/8 x 4 1/2	7/8	1/2
14	5 x 11 1/2	1 1/8 x 4 1/2	7/8	1/2

NOTE: 8 5/8 also available with 1 1/8" x 4 1/2" window – positioned 7/8" from the left and 1/2" from the bottom.

TYPES OF WINDOW MATERIALS USED

- **Poly (in some areas referred to as EZC)**

The most popular and cost-effective patching material, slightly frosted in appearance. Resistant to the effects of humidity, but will melt in the thermographic process.

- **Glassine**

Generally used on recycled orders. Glassine lacks clarity and does not react well under humid conditions. Safe for thermography, and 100% recyclable, because it is a wood product.

- **Crystal Clear (Cello)**

Completely transparent, but unable to withstand the heat of the thermographic process

- **Open Face**

Open windows have no patch material.

Double window envelopes do not need to have a patch on both windows, it is possible to leave one open and the other patched.

Be sure to specify when thermography for printing will be used on window envelopes.

TYPES OF PAPER USED FOR ENVELOPES

- White and Colored Wove
 - Kraft Paper
 - White
 - Brown
 - Gray
 - Manila
 - Other Colors Are Available
 - Recycled
 - Proprietary
 - Premium Sulphite
 - Cotton Papers
 - Translucent
 - Text
 - Opaque
 - Bond / Writing
 - Coated Paper
 - Matt / Dull / Gloss
-
- 500 sheets of the paper's Basic Size will determine the "Basis" weight, also referred to as the "Substance", or "Sub Weight".
 - For Example- 500 sheets of 24# Bond Paper 17" x 22" will weigh 24 lbs- 500 sheets of 70# text paper 25" x 38" will weigh 70 lbs.
 - It is not recommended to use paper heavier than 80# text for envelopes.
 - The most common weight for envelopes is 24#, larger open ends are usually 28#.
 - For more information on folding and scoring of these papers, look in Section D.

ENVELOPE STYLES

In this section you will find:

- Visual reference for nearly every envelope organized by style.

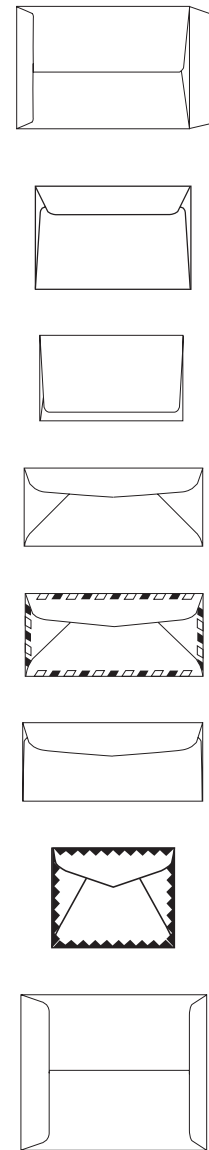

ENVELOPE STYLES

**BUSINESS CORRESPONDENCE
ENVELOPES:**

Commercial
Drug and Pay
Side-Seamed
Square Flap
Combination Statement & Return
Order Blank Forms
Air Mail
Wallet Flap
Safety Fold
Document
Filing Jacket
2-way Remittance
Simple Seal®
Proxy Dual-Pak
Proxy Bi-Pack

BOOKLET STYLE ENVELOPES:

Booklet
Peel &Seel® (open side)
Square
Mailers (open side)

A-STYLE ENVELOPES

BARONIAL SIZES

EXPANSION ENVELOPES

CATALOG STYLE ENVELOPES:

Catalog
Coins
Latex Seal Catalogs
Clasp
First Class Mailers (open end)
Peel &Seel® (open end)
Drive-in Bank
Payroll/Jeweler
Interdepartmental
Tac-N-Tac®
Jumbo™

SPECIALTY PRODUCTS:

Brilliant™ Clasp
Brilliant™ Catalogs
Brilliant™ Squares
Brilliant Holiday Collection™
Brilliant™ Presentation Folders
Brilliant™ Transluents
Brilliant™ Imaging Products
Prints Collection™
Medical Imaging Products
Durable Mailers™
Magnetic Hotel Key Envelopes
CD ROM Envelopes
Tyvek®
TX3®

BUSINESS CORRESPONDENCE ENVELOPES

Commercial

Frequently specified for a wide variety of business and personal correspondence purposes such as letterheads, invoices, statements, checks, stationery and direct marketing. These envelopes are open side, have diagonal seams and feature deep, sharply dropping shoulders, which offer a larger corner card printing area, making them ideally suited for machine insertion, laser and postal applications.

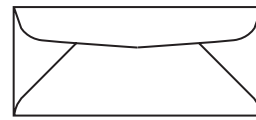

Item	Envelope Size	Enclosure Size
6 1/4	3 1/2 x 6	3 1/4 x 5 3/4
6 3/4	3 5/8 x 6 1/2	3 1/2 x 6 1/4
8 5/8	3 5/8 x 8 5/8	3 1/2 x 8 3/8
7	3 3/4 x 6 3/4	3 1/2 x 6 1/2
7 3/4*	3 7/8 x 7 1/2	3 3/4 x 7 1/4
Monarch*	3 7/8 x 7 1/2	3 3/4 x 7 1/4
9	3 7/8 x 8 7/8	3 3/4 x 8 5/8
10	4 1/8 x 9 1/2	4 x 9 1/4
11	4 1/2 x 10 3/8	4 1/4 x 10 1/8
12	4 3/4 x 11	4 1/2 x 10 3/4
14	5 x 11 1/2	4 3/4 x 11 1/4

*7 3/4 — commercial flap; Monarch — pointed flap

Drug and Pay

These small open side envelopes are produced in a variety of sizes, and are used by florists, druggists and other businesses.

Item	Envelope Size	Enclosure Size
1 Drug	1 3/4 x 2 7/8	1 1/2 x 2 3/4
2 Drug	2 1/16 x 3 1/2	1 13/16 x 3 1/4
3 Drug	2 5/16 x 3 5/8	2 1/16 x 3 3/8
2 Pay	2 1/2 x 4 1/4	2 1/4 x 4

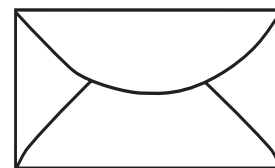

Side-Seam/E-Z Insert

This attractive, modern styling adds a touch of visual impressiveness to today's correspondence. It offers a larger printing area uninterrupted by seams. The straight grain cutting and the specially tapered seal flap and throat contribute to better performance in sealing and automatic inserting applications.

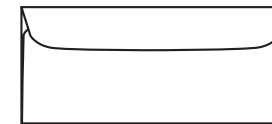

Item	Envelope Size	Enclosure Size
6 1/4	3 1/2 x 6	3 1/4 x 5 3/4
6 3/4	3 5/8 x 6 1/2	3 1/2 x 6 1/4
7 3/4	3 7/8 x 7 1/2	3 3/4 x 7 1/4
9	3 7/8 x 8 7/8	3 3/4 x 8 5/8
10	4 1/8 x 9 1/2	4 x 9 1/4

Square Flap

This contemporary flap style adds a touch of elegance to any business correspondence. Particularly popular as part of an executive stationery suite. Well suited for engraving, thermography and lithographic process, but not recommended for automatic insertion. Compatible with late model laser printers.

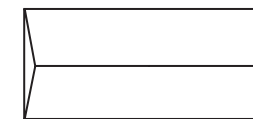

Item	Envelope Size	Enclosure Size
Monarch SF	3 7/8 x 7 1/2	3 3/4 x 7 1/4
9 SF	3 7/8 x 8 7/8	3 3/4 x 8 5/8
10 SF	4 1/8 x 9 1/2	4 x 9 1/4

Combination Statement & Return/Remittance

A return envelope with large printing surface ideal for mail order, subscriptions, donations, coupons, and general remittance needs. Usually included are different elements to facilitate a response from the recipient.

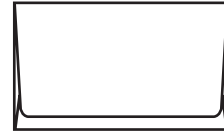

Item	Envelope Size	Enclosure Size
6 1/4	3 1/2 x 6	3 1/4 x 5 3/4
6 1/2	3 1/2 x 6 1/4	3 1/4 x 6
6 3/4	3 5/8 x 6 1/2	3 1/2 x 6 1/4
9	3 7/8 x 8 7/8	3 3/4 x 8 5/8
10	4 1/8 x 9 1/2	4 x 9 1/4

Order Blank Forms

Flat- not scored- gummed flaps.



Envelope Size
8 1/2 x 11

Air Mail

This envelope is used as a postage cost saver for international applications and is made from light-weight papers with red and blue borders, inside tint for opacity and air mail legends. May be used domestically but will not receive preferential handling or meet OCR requirements for the U.S. Post Office.

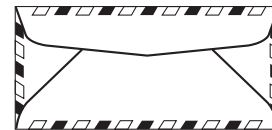

Item	Envelope Size	Enclosure Size
10	4 1/8 x 9 1/2	4 x 9 1/4

Wallet Flap

Mostly used by banks or investment firms for mailing statements and other documents. The deep flap and extra-wide gummed area offer extra protection to the contents.

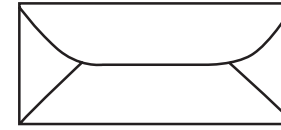

Item	Envelope Size	Enclosure Size
10	4 1/8 x 9 1/2	3 7/8 x 9 1/4
11	4 1/2 x 10 3/8	4 1/4 x 10 1/8
12	4 3/4 x 11	4 1/2 x 10 3/4
14	5 x 11 1/2	4 3/4 x 11 1/4
16	6 x 12	5 3/4 x 11 3/4

Document

Open side with two outside seams for easy inserting. The heavily gummed hexagon flap ensure security for the contents.

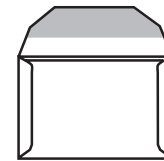

Envelope Size	Enclosure Size
9 x 12	8 3/4 x 11 3/4
9 1/2 x 12	9 1/4 x 11 1/2
9 1/2 x 12 1/2	9 1/4 x 12
10 x 13	9 3/4 x 12 1/2
10 x 15	9 3/4 x 14 1/2

Peel & Seal® Document

Available in 40 lb. Brown Kraft. These large envelopes open on the long dimension with 4" gum flap for extra security when mailing important documents.

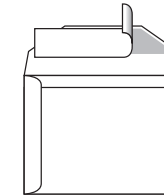

Envelope Size	Enclosure Size
9 x 12	8 3/4 x 11 3/4
9 1/2 x 12	9 1/4 x 11 1/2
9 1/2 x 12 1/2	9 1/4 x 12
10 x 13	9 3/4 x 12 1/2
10 x 15	9 3/4 x 14 1/2

Simple-Seal®

This envelope has two latex surfaces that seal on contact. Flaps are folded down to allow for printing processes. Efficient and convenient for small businesses and professional people, personal stationery.

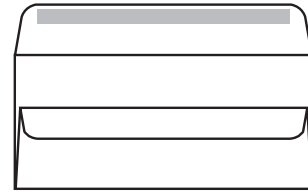

Item	Envelope Size	Enclosure Size
6 3/4	3 5/8 x 6 1/2	3 1/2 x 6 1/4
7 3/4*	3 7/8 x 7 1/2	3 3/4 x 7 1/4
9	3 7/8 x 8 7/8	3 3/4 x 8 5/8
10	4 1/8 x 9 1/2	4 x 9 1/4

*Also referred to as Monarch.

2-Way Remittance (Hitchhiker)

Dual purpose envelope; includes statement and provides for the return of orders and remittances. The large flap can be printed with message, detached at the perforation, inserted in the envelope and sealed. Ideal for financial receipts, memberships subscriptions, and fundraising.

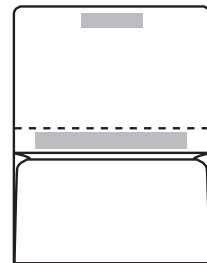

Overall Size	Mail Size	Return Size
8 3/8 x 6 1/2	4 1/4 x 6 1/2	3 5/8 x 6 1/2
8 3/8 x 8 7/8	4 1/4 x 8 7/8	3 5/8 x 8 7/8

Proxy Dual-Pack

Booklet style envelope with statement pocket and polyclear covered address window on face. For mailing annual reports and proxy statements. Envelope design is compatible with inserting equipment.

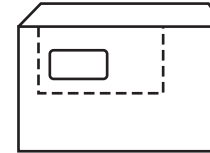

Item	Envelope Size	Enclosure Size
Proxy Dual-Pack	9 x 12	8 1/2 x 11
Window Size -	1 1/4 x 3 1/4	
Pocket Size -	3 1/2 x 8 1/2	

Proxy Bi-Pack

Booklet style envelope with window placement on back. Polyclear covered address window on back with pull-out tab and perfs. Data card/ statement pocket is placed on the back of the envelope.

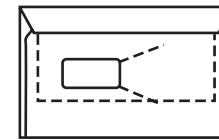

Item	Envelope Size	Enclosure Size
Proxy Bi-Pack	9 x 12	8 1/2 x 11
Window Size -	1 1/4 x 4 1/4	
Pocket Size -	4 3/8 x 9 1/4	

BOOKLET STYLE ENVELOPES

Booklet

For annual reports, brochures, sales literature and a variety of printed material. The booklet's open side style and side seams make it suitable for automatic insertion and the open side configuration allows for overall printing.

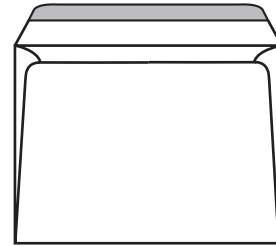

Item	Envelope Size	Enclosure Size
3	4 3/4 x 6 1/2	4 1/2 x 6
4 1/2	5 1/2 x 7 1/2	5 1/4 x 7
5	5 1/2 x 8 1/8	5 1/4 x 7 5/8
6	5 3/4 x 8 7/8	5 1/2 x 8 3/8
6 1/2	6 x 9	5 3/4 x 8 1/2
6 5/8	6 x 9 1/2	5 3/4 x 9
6 3/4	6 1/2 x 9 1/2	6 1/4 x 9
7 1/4	7 x 10	6 3/4 x 9 1/2
7 1/2	7 1/2 x 10 1/2	7 1/4 x 10
9	8 3/4 x 11 1/2	8 1/2 x 11
9 1/2	9 x 12	8 3/4 x 11 1/2
10	9 1/2 x 12 5/8	9 1/4 x 12 1/8
13	10 x 13	9 3/4 x 12 1/2

Peel & Seal® (Open Side)

When the release tape liner is removed and the flap is pressed down, it seals on contact without moisture.

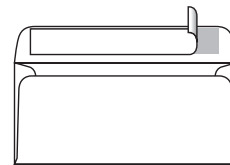

Item	Envelope Size	Enclosure Size
#10	4 1/8 x 9 1/2	4 x 9 1/4
9 1/2 Booklet	9 x 12	8 3/4 x 11 3/4
10 Booklet	9 1/2 x 12 5/8	9 1/4 x 12 3/8

First Class Mailers (Open Side)

Booklet style envelopes printed with diamond borders and first class to expedite postal handling. Can be used for mailing reports, manuscripts, brochures, and other flat materials. Not recommended for automated inserting postage meter.

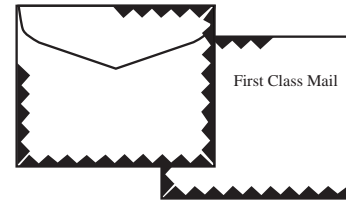

Item	Envelope Size	Enclosure Size
1st Class	9 x 12	8 3/4 x 11 3/4

Squares

With square flap, its side seam construction allows for printing uninterrupted by seams. Good choice for announcements, booklets, promotions. **All square envelopes require a surcharge for mailing.**

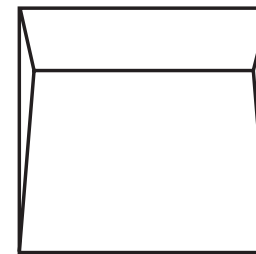

Item	Envelope Size	Enclosure Size
5	5 x 5	4 3/4 x 4 3/4
5 1/2	5 1/2 x 5 1/2	5 1/4 x 5 1/4
6	6 x 6	5 3/4 x 5 3/4
6 1/2	6 1/2 x 6 1/2	6 1/4 x 6 1/4
7	7 x 7	6 3/4 x 6 3/4
7 1/2	7 1/2 x 7 1/2	7 1/4 x 7 1/4
8	8 x 8	7 3/4 x 7 3/4
8 1/2	8 1/2 x 8 1/2	8 1/4 x 8 1/4
9	9 x 9	8 3/4 x 8 3/4
9 1/2	9 1/2 x 9 1/2	9 1/4 x 9 1/4
13 1/2	13 1/2 x 13 1/2	13 1/4 x 13 1/4

CATALOG STYLE ENVELOPES

Catalog

Open end style (opening on shorter dimension) with a center seam. For magazines and large booklets, as the heavily gummed flap offers protection for heavy enclosure. Cannot be processed through inserting equipment or laser printing.

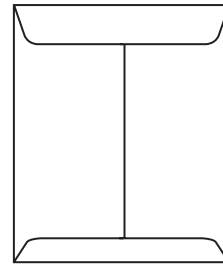

Item	Envelope Size	Enclosure Size
8 glove	3 7/8 x 7 1/2	3 5/8 x 7
7 glove	4 x 6 3/8	3 3/4 x 5 7/8
1 scarf	4 5/8 x 6 3/4	4 3/8 x 6 1/4
3 scarf	5 x 7 1/2	4 3/4 x 7
4 1/2 scarf	5 1/2 x 7 1/2	5 1/4 x 7
6 scarf	5 1/2 x 8 1/4	5 1/4 x 7 3/4
10 policy	4 1/8 x 9 1/2	3 7/8 x 9
11 policy	4 1/2 x 10 3/8	4 1/4 x 9 7/8
12 policy	4 3/4 x 11	4 1/2 x 10 1/2
14 policy	5 x 11 1/2	4 3/4 x 11
1 catalog	6 x 9	5 3/4 x 8 1/2
1 3/4 catalog	6 1/2 x 9 1/2	6 1/4 x 9
3 catalog	7 x 10	6 3/4 x 9 1/2
6 catalog	7 1/2 x 10 1/2	7 1/4 x 10
8 catalog	8 1/4 x 11 1/4	8 x 10 3/4
8 1/2 catalog	8 1/2 x 10 1/2	8 1/4 x 10
9 3/4 catalog	8 3/4 x 11 1/4	8 1/2 x 10 3/4
10 1/2 catalog	9 x 12	8 3/4 x 11 1/2
12 1/2 catalog	9 1/2 x 12 1/2	9 1/4 x 12
13 1/2 catalog	10 x 13	9 3/4 x 12 1/2
14 1/2 catalog	11 1/2 x 14 1/2	11 1/4 x 14
15 catalog	10 x 15	9 3/4 x 14 1/2
15 1/2 catalog	12 x 15 1/2	11 3/4 x 15

Coins

Small size envelope for multi-purpose uses: for coins, small parts, etc. Most coin envelopes are not mailable or suitable for automatic processes.

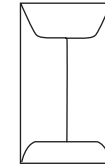

Item	Envelope Size	Enclosure Size
00	1 11/16 x 2 3/4	1 7/16 x 2 1/2
1	2 1/4 x 3 1/2	2 x 3 1/4
3	2 1/2 x 4 1/4	2 1/4 x 4
4	3 x 4 1/2	2 3/4 x 4 1/4
4 1/2	3 x 4 7/8	2 3/4 x 4 5/8
5	2 7/8 x 5 1/4	2 5/8 x 5
5 1/2	3 1/8 x 5 1/2	2 7/8 x 5 1/4
6	3 3/8 x 6	3 1/8 x 5 3/4
7	3 1/2 x 6 1/2	3 1/4 x 6 1/4

Latex Seal Catalog

Similar style as catalog, but with a latex closure consisting of latex gum strips applied to the body and flap of the envelope. When folded, flaps seal together without requiring moisture.

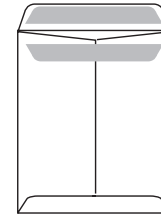

Item	Envelope Size	Enclosure Size
1 catalog	6 x 9	5 3/4 x 8 1/2
1 3/4 catalog	6 1/2 x 9 1/2	6 1/4 x 9
6 catalog	7 1/2 x 10 1/2	7 1/4 x 10
10 1/2 catalog	9 x 12	8 3/4 x 11 1/2
12 1/2 catalog	9 1/2 x 12 1/2	9 1/4 x 12
13 1/2 catalog	10 x 13	9 3/4 x 12 1/2
15 catalog	10 x 15	9 3/4 x 14 1/2
14 1/2 catalog	11 1/2 x 14 1/2	11 1/4 x 14
15 1/2 catalog	12 x 15 1/2	11 3/4 x 15

Clasp

Open end style, similar to the catalog, but with a metal clasp, which ensures protection to its contents. Usually inserted by hand is not suitable for printing or mechanical applications after converting.

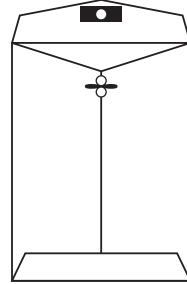

Item	Envelope Size	Enclosure Size
15	4 x 6 3/8	3 3/4 x 5 7/8
25	4 5/8 x 6 3/4	4 3/8 x 6 1/4
35	5 x 7 1/2	4 3/4 x 7
40	5 1/2 x 7 1/2	5 1/4 x 7
55	6 x 9	5 3/4 x 8 1/2
63	6 1/2 x 9 1/2	6 1/4 x 9
68	7 x 10	6 3/4 x 9 1/2
75	7 1/2 x 10 1/2	7 1/4 x 10
83	8 1/2 x 11 1/2	8 1/4 x 11
87	8 3/4 x 11 1/4	8 1/2 x 10 3/4
90	9 x 12	8 3/4 x 11 1/2
93	9 1/2 x 12 1/2	9 1/4 x 12
95	10 x 12	9 3/4 x 11 1/2
97	10 x 13	9 3/4 x 12 1/2
98	10 x 15	9 3/4 x 14 1/2
105	11 1/2 x 14 1/2	11 1/4 x 14
110	12 x 15 1/2	11 3/4 x 15

Payroll/Jeweler

Open style envelope used for special applications like payroll and small jewelry.



Item	Envelope Size	Enclosure Size
5 1/2 Coupon	3 1/8 x 5 1/2	2 7/8 x 5 1/4

First Class Mailers (Open End)

Catalog style envelopes printed with green diamond border and First Class to expedite postal handling. Available with regular seal adhesive(gum), latex seal and Peel & Seal®

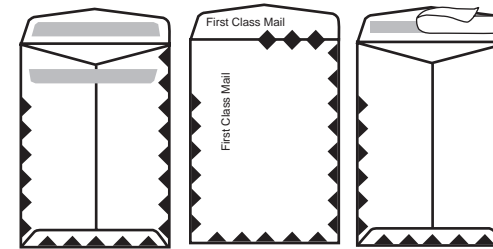

Item	Envelope Size	Enclosure Size
1st Class	9 x 12	8 3/4 x 11 1/2
1st Class	9 1/2 x 12 1/2	9 1/4 x 12
1st Class	10 x 13	9 3/4 x 12 1/2

Peel & Seal® (Open End)

When the release tape liner is removed and the flap is pressed down it seals on contact without moisture. Printing after the envelope is folded can be accomplished without interfering with the quality of the seal.

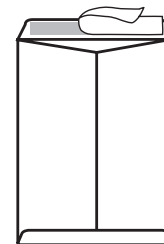

Item	Envelope Size	Enclosure Size
1 Catalog	6 x 9	5 3/4 x 8 1/2
1 3/4 Catalog	6 1/2 x 9 1/2	6 1/4 x 9
6 Catalog	7 1/2 x 10 1/2	7 1/4 x 10
10 1/2 Catalog	9 x 12	8 3/4 x 11 1/2
12 1/2 Catalog	9 1/2 x 12 1/2	9 1/4 x 12
13 1/2 Catalog	10 x 13	9 3/4 x 12 1/2
15 Catalog	10 x 15	9 3/4 x 14 1/2
14 1/2 Catalog	11 1/2 x 14 1/2	11 1/4 x 14
15 1/2 Catalog	12 x 15 1/2	11 3/4 x 15

Interdepartmental

This style envelope is commonly used for interoffice correspondence, has ungummed flap, eight holes, printed route listing on front and back. Can be plain or with button and string closure to assure privacy for the contents. Printing, closure and number of holes can vary to meet material requirements.

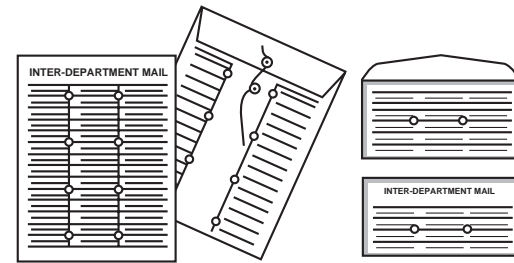

Item	Envelope Size	Enclosure Size
*No. 11	4 1/2 x 10 3/8	4 1/4 x 10 1/8
**10 x 13	10 x 13	9 3/4 x 12 1/2

* Commercial style with two holes.
 ** Also available with Tac-n-Tac™ closure.

Tac-n-Tac®

A special spot seal tape closure allows for repeat sealing of flap.

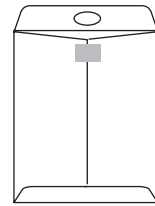

Item	Envelope Size	Enclosure Size
13 1/2 Catalog	10 x 13	9 3/4 x 12 1/2

Drive-In Bank

Open end style envelope with scored and extended flap are available with plain flap (no gum) or latex seal.

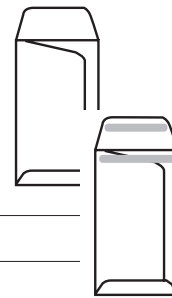

Envelope Size	Enclosure Size
3 1/4 x 7	3 x 6 3/4
3 3/4 x 7	3 1/2 x 6 3/4

Jumbo

Jumbo envelopes are available in brown, gray and white kraft with plain flap (no gum) or gummed flap. They are used by advertising agencies, printers, architects, engineering firms, photographers, hospitals etc. requiring larger than standard size envelopes.

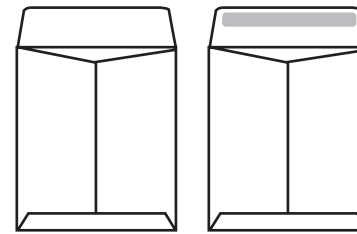

Envelope Size	Enclosure Size
11 x 17	11 3/4 x 16 1/2
12 1/2 x 16	12 1/4 x 15 1/2
12 x 17	11 3/4 x 16 1/2
12 1/2 x 18 1/2	12 1/4 x 18
13 1/2 x 13 1/2	13 1/4 x 13
13 x 17	12 3/4 x 16 1/2
13 x 19	12 3/4 x 18 1/2
14 x 16	13 3/4 x 15 1/2
14 x 18	13 3/4 x 17 1/2
14 x 21	13 3/4 x 20 1/2
15 x 18	14 3/4 x 17 1/2
15 x 20	14 3/4 x 19 1/2
15 x 22	14 3/4 x 21 1/2
16 x 20	15 3/4 x 19 1/2
17 x 22	16 3/4 x 21 1/2
18 x 23	17 3/4 x 22 1/2
19 x 26	18 3/4 x 25 1/2
20 x 25	19 3/4 x 24 1/2
22 x 27	21 3/4 x 26 1/2
24 x 30	23 3/4 x 29 1/2
24 x 36	23 3/4 x 35 1/2

EXPANSION ENVELOPES

Our expansions are precision manufactured from steel rule die cut and pre-scored envelope blanks. Envelopes manufactured bag bottom style means the side gussets are folded in at the time of manufacture, but the bottom gusset is folded out. Box bottom style has both the side and bottom gussets folded prior to use. Both style bottoms are identical when they are inserted. Expansion envelopes manufactured with a box bottom are available at an extra charge.

Measuring Expansion Envelopes

1. Measure with envelope fully expanded.
2. Determine width.
3. Determine length (distance between two inner most scores).
4. Determine expansion.
5. Determine flap size.
6. Determine if Bag Bottom "V" style (side gussets folded in, but bottom gusset is folded out) or Box Bottom "W" style (side and bottom gussets are folded in).
7. Determine if Open End or Open Side. If Open Side, specify with center and bottom seams or two side seams.
8. If adding Button and String or Clasp closure, determine if envelope will be used with or without full expansion at flap.

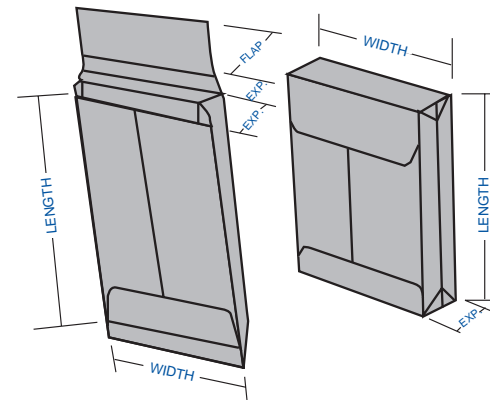

Expansion Envelopes Are Manufactured To Order - Call your Local Division for more Information

Minimum expansion 1" ; maximum expansion 4". Closure can be with regular gum, latex gum, or Peel & Seal®.

Pictorial Index:

- A. Jumbo
- B. Open-Side, Box-Bottom
- C. Open-Side, Box-Bottom (W) Wallet
- D. Open-End, Bag-Bottom (V-Style)
- E. Open-Side, Bag-Bottom (V-Style)
- F. Bank Statement (Window & Pocket)
- G. Open-Side Document Style
- H. Flat Safety Fold
- I. Security Mailer
- J. First Class mail
- K. Reinforced Tab File Jacket
Box Bottom Style
- L. Open-Side Reinforced Shelf Tab

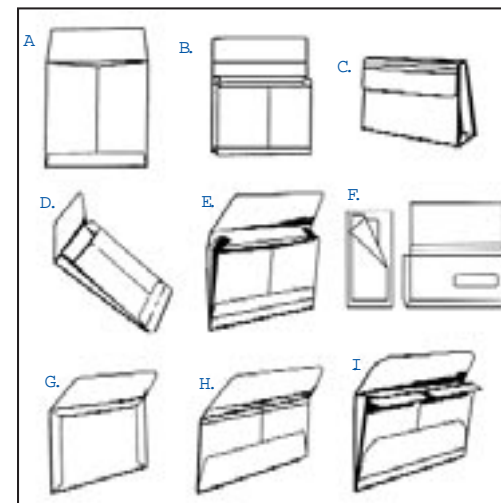

Size Available:

- $4\frac{1}{8} \times 9\frac{1}{2} \times 2$
- $5 \times 11 \times 2$
- $5 \times 11 \times 3$
- $10 \times 12 \times 1\frac{1}{2}$
- $10 \times 12 \times 2$
- $10 \times 13 \times 1\frac{1}{2}$
- $10 \times 13 \times 2$
- $10 \times 15 \times 2$
- $11 \times 14\frac{1}{2} \times 2$
- $11 \times 15 \times 2$
- $12 \times 15 \times 2$
- $12 \times 15 \times 3$
- $12 \times 16 \times 2$

SPECIAL PURPOSE ENVELOPES

File-velope & File Jacket

File-velope is an open side/inside side seams envelope produced from heavy weight papers such as 32 lb. Manila Kraft and 125 lb. Manila Tag.

File Jackets are open side/outside side seams to facilitate insertion of material and produced from 40 lb. Brown Kraft and 125 lb. Manila tag.

File-velope
9 x 11 3/4

File Jacket
8 3/4 x 11 3/4
8 3/4 x 15

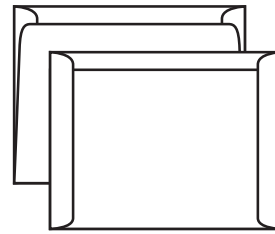

Filing Envelopes

Filing Envelopes are Open End/Center Seam envelopes produced from either Brown, Gray or White Kraft paper. The finished size of these envelopes is specified by the customer. The chart below shows the industry's standard "width" and "height up to" on each size envelope. The customer orders the width as shown and chooses the height up to any size, as the chart indicates. The opening for filing envelopes is always along the width.

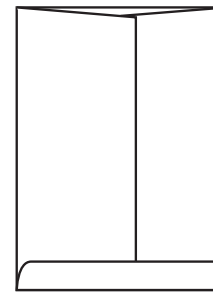

Job Ticket

Manufactured from Manila Tag or Coated One Side Carbonless paper. These envelopes offer an extra smooth surface for printing or writing.

Envelope Size
8 3/4 x 11 1/4
9 1/2 x 12

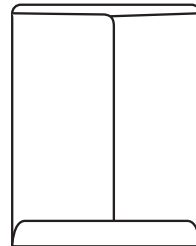

Width (Opening)		Height (Up to)	
9	17 1/2	16	19 1/2
9 1/2	12 1/4	16 1/2	16
10	17 1/2	17	21 1/2
11	16 1/2	17 1/2	17
11 1/2	14	18	22 1/2
12	14	18 1/2	18
12 1/2	18	19	25 1/2
13	16 1/2	19 1/2	19
13 1/2	18	20	24 1/2
14	20 1/2	20 1/2	20
14 1/2	14	21	23 1/2
15	21 1/2	21 1/2	21
15 1/2	15	22	26 1/2

Perfect Vision® Display

Available in White Kraft and assorted colors. These booklet style envelopes contain an oversized window centered on the face of the envelope. Ideal for mailing catalogs, annual reports and sales literature.

Item Window Size
6 x 9 4 x 7
9 x 12 6 1/2 x 9 1/2

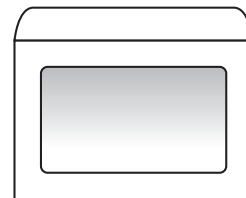

Securomail® Safety-Fold

Open side with center and bottom seams, top and bottom “safety” fold. Bottom seams are deep and the heavily gummed seal flap area ensure complete security.

Envelope Size	Enclosure Size
5 x 11	4 3/4 x 10 3/4
5 1/2 x 11 1/2	5 1/4 x 11 1/4
6 x 12	5 3/4 x 11 3/4
10 x 13	9 3/4 x 12 3/4
10 x 15	9 3/4 x 14 3/4

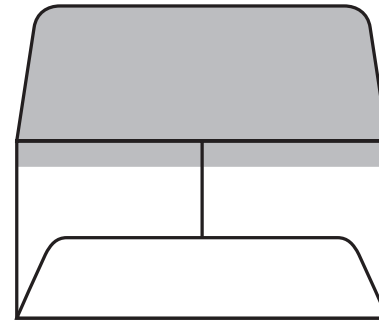

Peel & Seal® Envelopes of Tyvek®*

Envelopes of Tyvek®, spunbonded olefin, are the cost-efficient alternative to kraft envelopes. These strong, yet lightweight, envelopes provide that extra margin of protection against loss or damage of valuable mailings, and the light weight reduces postage costs.

Size	Plain		Printed First Class		Printed Air Mail
	Sub 14	Sub 18	Sub 14	Sub 18	Sub 14
6 x 9	•		•		
6 1/2 x 9 1/2	•		•		
7 1/2 x 10 1/2	•				
9 x 12	•	•	•		•
9 x 12 OS		•			
9 1/2 x 12 1/2	•	•	•		
10 x 13	•	•	•	•	•
10 x 13 OS		•		•	
10 x 15	•		•		
11 1/2 x 14 1/2	•				
12 x 15 1/2	•	•	•		

NOTE: All items are open end unless otherwise noted.

Expansion Envelopes

Size	Plain	First Class
	Sub 18	Sub 18
10 x 13 x 1 1/2 OE	•	•
10 x 13 x 2 OS	•	•
10 x 15 x 2 OS	•	•
12 x 16 x 2 OE	•	•
12 x 16 x 2 OS	•	•

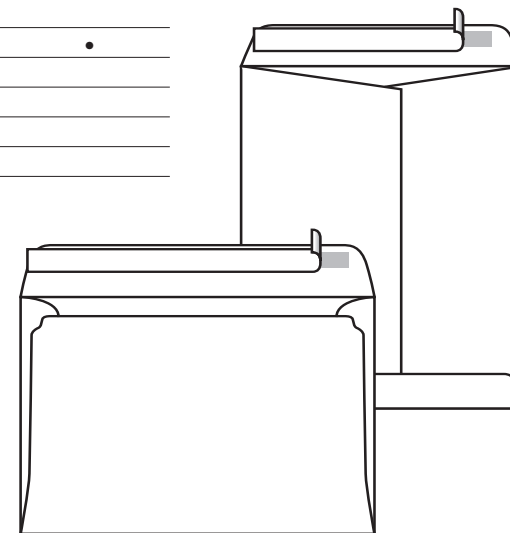

* DuPont Tyvek® 25% Post-Consumer Content 

MEDICAL IMAGING PRODUCTS

Negative Preservers

Available in Sub. 28 and Sub. 32 Brown, Gray, Red and Green Kraft. Stocked in sizes to accommodate X-ray film. Negative Preservers are available open end or open top, thumb-cut, plain or printed.

- Size _____
8 1/2 x 10 1/2 (Open End)
10 1/2 x 12 1/2 (Open End)
11 1/2 x 14 1/2 (Open End)

14 1/2 x 17 1/2 (Open Top)

14 1/2 x 17 1/2 (Open Side)



Expansion Jacket

Available in Sub. 40 Brown Kraft, the Expansion X-Ray master jacket is an open top envelope with 1" gusset. It also is printed and thumb cut.

- Size _____
14 1/2 x 17 1/2 x 1



Custom Category Inserts

Custom Color Border Sleeves are category jackets which may be personalized to fulfill specific category filing needs. these category inserts are available with a printed 4-sided border or plain (no printing), all of which are produced from White Kraft paper.

- Size _____
14 1/4 x 17 1/2 (Open End)

Printed Border Colors

Black	Light Green #375
Process Blue	Gray #430
Yellow #109	Purple #527
Gold #117	Kelly Green #568
Orange #165	Yellow Green #381
Brown #168	Olive #582
Rust #180	Lavender #270
Red #185	Putty #454
Magenta #233	Manila #134
Dark Blue #287	Turquoise #326

- Size _____
10 1/2 x 12 1/2 (Open End)

Border only. Plain, no printing.



Category Inserts, System I/Mailwell, System II/Ames and Others

Category inserts are available in four standard formats, all of which are thumb cut and are produced from Kraft paper. These jackets are provided with system compatible color coded borders.

Size

10 1/2 x 12 1/2 (Open End)

14 1/4 x 17 1/2 (Open End)

17 1/2 x 14 1/4 (Open End)

Description	System I Border Color	Description	System II Border Color
Abdomen	Yellow/Green	Abdomen	Red
Angio	Magenta	Angio	Stone
B.E.	Gold	B.E.	Gold
Bone	Yellow	Bone	Yellow
Bone Densitometry	Yellow	Chest	Briar
Chest	Brown	C.T.	Khaki
C.T.	Kelly Green	C.T. (Khaki Kraft)	Black
D.S.A.	Magenta	D.S.A.	Blue
Extremities	Yellow	G.I.	Putty
Gall Bladder	Light Green	G.U.	Orange
G.I.	Gray	Head and Neck	Lt. Blue
G.U.	Orange	I.V.P.	Orange
Head and Neck	Blue	Mammography	Pink
I.V.P.	Peach	Miscellaneous	-
Mammography	Dark Blue	M.R.I.	Black
Miscellaneous	-	Nuclear Medicine	Manila
M.R.I.	Rust	Radiation Oncology	Orange
Nuclear Medicine	Red	Special Procedure	Olive
Radiation Oncology	Yellow	Spine	Green
Special Procedure	Olive	Ultra Sound	Gray
Spine	Black	Ultra Sound (Gray Kraft)	Blue
Ultra Sound	Purple		



Description	Other Systems Border Color
Abdomen	Lavender #270
Abdomen	Plain/No Border
B.E. (Barium Enema)	Putty #454
Chest	Lt. Brown #152
C.T. (Cat Scan)	Red #185
C.T. (Cat Scan)	No Border/Black
Mammography	Manila #134
Mammography	No Border/Black
M.R.I.	Turquoise #326
M.R.I.	Gray #421
Myelogram	Lavender #270
P.E.T.	Orange #165

Film Mailer, Open End

X-Ray mailers may be supplied with an ungummed flap, latex sealing flap, or button and string fastener. They are also available with a first class green diamond border, which expedites postal handling. These envelopes are made from heavy duty Brown Kraft or Manila stock.

Size

11 x 13

15 x 18



ANNOUNCEMENTS

There are two basic uses for announcements: **Commercial** and **Social** occasions.

These items can be used for both announcements and invitations, commemorating business openings, changes of address, notifications of promotion, and other social and commercial events.

Commercial Announcements are usually supplied with a single gummed envelope. *Social Announcements*, used as invitations, are supplied, in most cases, with an inside ungummed envelope and an outside gummed envelope. Both are produced in a variety of sizes, papers and colors, and are available in both plain and panel cards and folders.

Commercial Announcements

The most commonly used type of announcement is the baronial card or folder. Baronials are usually manufactured using a vellum finished paper in both white and ivory. In recent years, a greater variety of papers have become available in a multitude of colors and finishes.

The baronial style announcement envelope is supplied in 5 standard sizes.

Commercial Announcements are packaged in two different formats. The economy grades, which are normally 14 pt. card stock and 24 lb. envelopes, are packaged 500 per box and 5M per carton.

The premium grades are generally 16 pt. card stock and 28 lb. envelopes. These items are packaged 250 per box and the usual carton packaging is 2500 per carton for all sizes.

Matching folders are available for most of these sizes. These folders are generally 100 lb. stock (Basis 25 x 38/500). These items are normally packaged 250 per box and 2 1/2M per carton.

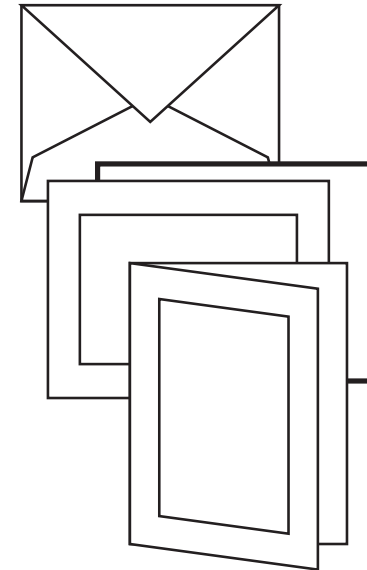

Item	Envelope Sizes	Card Size	Folder Size	Panel margin
4 Baronial	3 5/8 x 5 1/8	3 1/2 x 4 7/8	4 7/8 x 7	1/2
5 Baronial	4 1/8 x 5 5/8	4 x 5 1/4	(not stocked)	1/2
5 1/2 Baronial	4 3/8 x 5 3/4	4 1/4 x 5 1/2	5 1/2 x 8 1/2	1/2
6 Baronial	4 3/4 x 6 1/2	4 5/8 x 6 1/4	6 1/4 x 9 1/4	5/8
Lee	5 1/4 x 7 1/4	5 1/8 x 7	6 5/8 x 10 7 x 10 1/4	Card 5/8 Folder 3/4 or 5/8

Social Announcements

There are two basic categories of Social Announcements: *Traditional* and *Contemporary*.

- **Traditional Announcements** are manufactured from white and natural shades of papeterie papers. Some traditional announcements are produced from cotton fiber paper, but today most are made from high grade sulphite paper. The matching envelope style is normally diagonal seam, pointed flap. The folders and cards may be produced either with or without a debossed panel.
- **Contemporary Announcements** cover a wide range of styles and papers. They may incorporate color in the design as well as a variety of colored inks in the personalization of the announcement. The paper used in contemporary announcements may be vellum, laid, texture or parchment finishes. Deckle edge papers are often used in these newer styled announcements. The matching envelopes may be square flap (side seam) or pointed flap (diagonal seam).

Social Announcements are available in a wide variety of sizes. They are packaged both bulk in cartons for high volume users, as well as in the retail cabinet pack. In bulk pack, envelopes are packaged separately from the invitations. Cabinets for the invitations consist of 52 sheets, 50 ungummed inside, 50 gummed outside envelopes and 50 tissues. The box is shrink wrapped for cleanliness and easy display, with a lid on the bottom for reuse in delivering the printed invitation to the end user. Cabinets for Thank You's, Reception and Response Folders or Cards are packed 102 sheets with 100 outside envelopes. This box is also shrink wrapped.

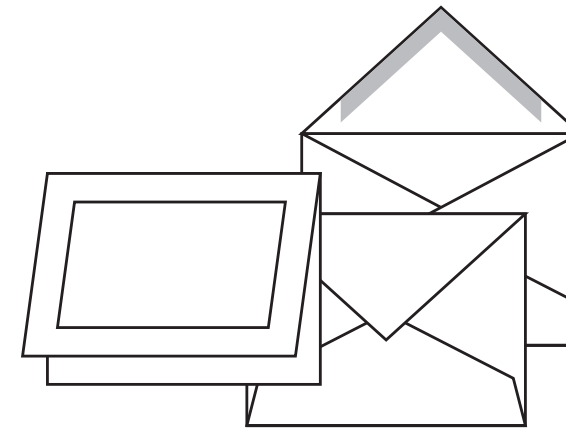

Item	Envelope Size*	Card Size	Panel Margin
Business Announcements			
Gladstone	3 ⁹ / ₁₆ x 5 ⁹ / ₁₆	3 ³ / ₈ x 5 ³ / ₈	1/2
4 Baronial	3 ⁵ / ₈ x 5 ¹ / ₈	3 ¹ / ₂ x 4 ⁷ / ₈	1/2
21	4 x 5 ¹⁵ / ₁₆	3 ⁷ / ₈ x 5 ³ / ₄	1/2
5 Baronial	4 ¹ / ₈ x 5 ⁵ / ₈	4 x 5 ¹ / ₄	1/2
53	4 ¹ / ₈ x 6 ¹ / ₄	4 x 6	5/8
5 ¹ / ₂ Baronial	4 ³ / ₈ x 5 ³ / ₄	4 ¹ / ₄ x 5 ¹ / ₂	1/2
6 Baronial	4 ³ / ₄ x 6 ¹ / ₂	4 ⁵ / ₈ x 6 ¹ / ₄	5/8
110	5 x 7 ¹ / ₄	4 ³ / ₄ x 7	3/4
Lee	5 ¹ / ₄ x 7 ¹ / ₄	5 ¹ / ₈ x 7	5/8 or 3/4
137	5 ¹ / ₂ x 8 ¹ / ₂	5 ¹ / ₄ x 8 ¹ / ₄	3/4

**Baronial Pointed Flap Diagonal Seam Announcement
Envelopes with matching Plain or Panel Cards and Folders**

Traditional announcements are manufactured from white and ivory shades of papeterie papers; however, they are also available in colors and finishes. The folders and cards may be produced either with or without a debossed panel.

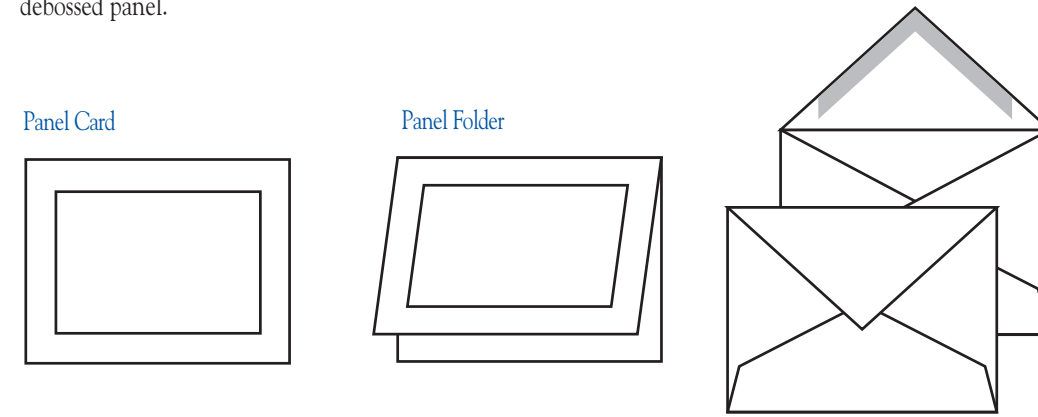

Item	Envelope Sizes	Card Size	Folder Size	Panel margin
4 Baronial	3 5/8 x 5 1/8	3 1/2 x 4 7/8	4 7/8 x 7	1/2
5 Baronial	4 1/8 x 5 5/8	4 x 5 1/4	(not stocked)	
5 1/2 Baronial	4 3/8 x 5 3/4	4 1/4 x 5 1/2	5 1/2 x 8 1/2	1/2
6 Baronial	4 3/4 x 6 1/2	4 5/8 x 6 1/4	6 1/4 x 9 1/4	5/8
Lee	5 1/4 x 7 1/4	5 1/8 x 7	6 5/8 x 10 7 x 10 1/4	Card 5/8 Folder 3/4 or 5/8

Product Size Comparison

A2 = 5 1/2 Baronial
A6 = 6 Baronial
A7 = Lee

A-Style Square Flap Envelopes and Announcements

For use with announcements, small booklets, brochures or promotional pieces, and more recently for distinctive business stationary. This style envelope is enhanced by the use of text paper. Use this chart to determine the most appropriate A-Style envelope and enclosure size.

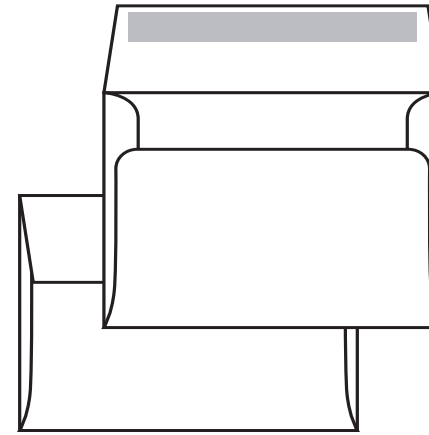

Narrowfold Card

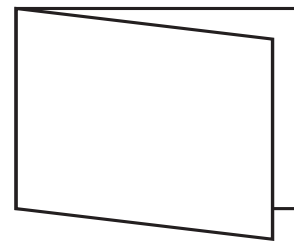

Broadfold Card

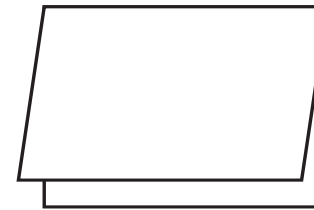

French Fold Sheet

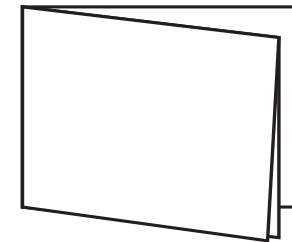

Item	Envelope Size	Single Card	Narrowfold Card	Broadfold Card	French Fold Sheet
A-2	4 ³ / ₈ x 5 ³ / ₄	4 ¹ / ₄ x 5 ¹ / ₂	4 ¹ / ₄ x 11	5 ¹ / ₂ x 8 ¹ / ₂	8 ¹ / ₂ x 11
A-6	4 ³ / ₄ x 6 ¹ / ₂	4 ¹ / ₂ x 6 ¹ / ₄	4 ¹ / ₂ x 12 ¹ / ₂	6 ¹ / ₄ x 9	9 x 12 ¹ / ₂
A-7	5 ¹ / ₄ x 7 ¹ / ₄	5 ¹ / ₈ x 7	5 x 14	7 x 10	10 x 14
A-8	5 ¹ / ₂ x 8 ¹ / ₈	5 ³ / ₈ x 7 ⁷ / ₈	5 ¹ / ₄ x 15 ¹ / ₂	7 ³ / ₄ x 10 ¹ / ₂	10 ¹ / ₂ x 15 ¹ / ₂
A-9	5 ³ / ₄ x 8 ³ / ₄	5 ⁵ / ₈ x 8 ⁵ / ₈	5 ¹ / ₂ x 17 ¹ / ₂	8 ¹ / ₂ x 11	11 x 17 ¹ / ₂
A-10	6 x 9 ¹ / ₂	5 ⁷ / ₈ x 9 ¹ / ₄	5 ³ / ₄ x 18 ¹ / ₂	9 ¹ / ₄ x 11 ¹ / ₂	11 ¹ / ₂ x 18 ¹ / ₂
Slimline	3 ⁷ / ₈ x 8 ⁷ / ₈	3 ³ / ₄ x 8 ⁵ / ₈	3 ³ / ₄ x 17 ¹ / ₄	8 ⁵ / ₈ x 7 ¹ / ₂	7 ¹ / ₂ x 17 ¹ / ₄

SHIPPING WEIGHTS PER M FOR COMMON ENVELOPE STYLES AND SIZES

Booklet Envelopes, Open Side/Side Seam

Item	Sizes	Sub 24	Sub 28
3	4 3/4 x 6 1/2	12	14
5	5 1/2 x 8 1/8	16	19
6	5 3/4 x 8 7/8	18	21
6 1/2	6 x 9	20	23
6 5/8	6 x 9 1/2	21	25
6 3/4	6 1/2 x 9 1/2	23	26
7 1/4	7 x 10	25	28
7 1/2	7 1/2 x 10 1/2	28	32
9	8 3/4 x 11 1/2	36	41
9 1/2	9 x 12	38	43
10	9 1/2 x 12 5/8	42	48
13	10 x 13	45	51

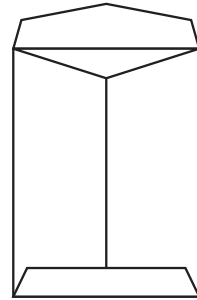
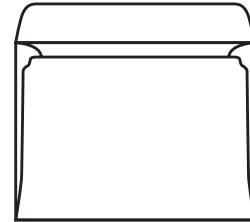

Catalog, Glove and Policy Envelopes

Item	Sizes	Sub 24	Sub 28
7 Glove	4 x 6 3/8	9	11
8	3 7/8 x 7 1/2	11	13
10 Policy	4 1/8 x 9 1/2	15	17
11	4 1/2 x 10 3/8	18	20
14	5 x 11 1/2	21	24
1 Scarf	4 5/8 x 6 3/4	12	14
3	5 x 7 1/2	14	17
4 1/2	5 1/2 x 7 1/2	16	19
6	5 1/2 x 8 1/4	18	23
1 Catalog	6 x 9	22	25
1 3/4	6 1/2 x 9 1/2	24	28
3	7 x 10	27	32
6	7 1/2 x 10 1/2	30	34
8	8 1/4 x 11 1/4	33	38
9 3/4	8 3/4 x 11 1/4	35	40
10 1/2	9 x 12	38	45
12 1/2	9 1/2 x 12 1/2	43	49
13 1/2	10 x 13	46	53
14 1/2	11 1/2 x 14 1/2	57	66
15	10 x 15	51	59
15 1/2	12 x 15 1/2	63	73

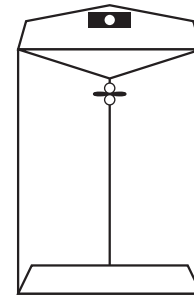

Clasp Envelopes, Open End/Center Seam

Item	Sizes	Sub 24	Sub 28
No. 5	3 1/8 x 5 1/2	8	10
No. 10	3 3/8 x 6	11	13
No. 15	4 x 6 3/8	13	16
No. 11	4 1/2 x 10 3/8	22	25
No. 25	4 5/8 x 6 3/4	17	19
No. 35	5 x 7 1/2	22	25
No. 14	5 x 11 1/2	27	30
No. 50	5 1/2 x 8 1/4	23	26
No. 55	6 x 9	26	29
No. 63	6 1/2 x 9 1/2	28	32
No. 68	7 x 10	35	39
No. 75	7 1/2 x 10 1/2	37	41
No. 83	8 1/2 x 11 1/2	42	46
No. 87	8 3/4 x 11 1/4	44	49
No. 90	9 x 12	49	55
No. 93	9 1/2 x 12 1/2	53	59
No. 94	9 1/4 x 14 1/2	58	73
No. 95	10 x 12	49	55
No. 97	10 x 13	54	61
No. 98	10 x 15	63	71
No. 105	11 1/2 x 14 1/2	70	79
No. 110	12 x 15 1/2	77	87

Baronial Flap envelopes

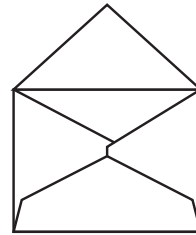

Item	Sizes	Flap	Sub 24	Sub 28	Sub 32
4 Baronial	3 5/8 x 5 1/8	Pointed	7	8	9
5 Baronial	4 1/8 x 5 1/2	Pointed	8	9	10
5 1/2 Baronial	4 3/8 x 5 3/4	Pointed	9	10	11
6 Baronial	4 3/4 x 6 1/2	Pointed	11	12	13
Lee	5 1/4 x 7 1/4	Pointed	13	14	16

Square Flap Envelopes

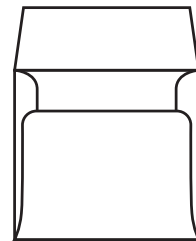

Item	Sizes	Flap	Sub 60	Sub 70	Sub 75	Sub 80
A-2	4 3/8 x 5 3/4	Square	9	11	12	12 1/4
A-6	4 3/4 x 6 1/2	Square	12	14	15	15 1/2
A-7	5 1/4 x 7 1/4	Square	15	17	17 1/4	18
A-8	5 1/2 x 8 1/8	Square	18	20	20 1/2	21
A-9	5 3/4 x 8 3/4	Square	20	23	25	26
A-10	6 x 9 1/2	Square	26	28	30	31
Slimline	3 7/8 x 8 7/8	Square	12	14	15	16
#10	4 1/8 x 9 1/2	Square	14	15	16	18
9 1/2 Booklet	9 x 12	Booklet	39	43	44	45

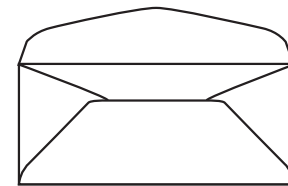

Commercial/Official Envelopes

Item	Sizes	Flap	Sub 20	Sub 22	Sub 24
6 1/2	3 1/2 x 6	Commercial	7	8	8
6 3/4	3 5/8 x 6 1/2	Commercial	7	8	9
7	3 3/4 x 6 3/4	Commercial	8	9	10
Monarch	3 7/8 x 7 1/2	Pointed	10	11	12
7 3/4	3 7/8 x 7 1/2	Commercial	10	11	11
8 5/8	3 5/8 x 8 5/8	Commercial	10	11	12
9	3 7/8 x 8 7/8	Commercial	10	11	12
10	4 1/8 x 9 1/2	Commercial	12	13	14
11	4 1/2 x 10 3/8	Commercial	-	-	17
12	4 3/4 x 11	Commercial	-	-	19
14	5 x 11 1/2	Commercial	-	-	20

ENHANCEMENTS

In this section you will find:

- General information on envelope enhancements.
- Order checklist
- Printing: Offset
Flexography
Embossing
Foil Stamping
Litho Converting
Laser Printing
- Embellishment Processes
- Inside Tints

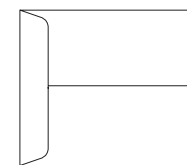
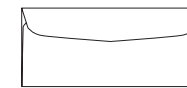
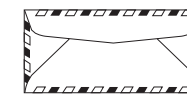
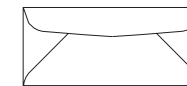
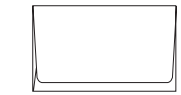
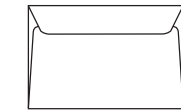

ENHANCEMENTS

NATIONAL / WILLIAMHOUSE ENVELOPE AS A JOB SHOP FOR YOUR CUSTOMERS

Many printers, large and small, do not have presses capable of printing envelopes. Even many small printers who may have the proper presses may not have purchased envelope feeders for those presses. They therefore find it more economical to have NATIONAL / WILLIAMHOUSE print the envelopes for them. In fact, some printers have found this to be more profitable since they can use their presses for work more commonly done day in and day out, without changing the presses, adding a feeder or making other adjustments necessary to run envelopes.

Most paper sales personnel, of course, are accustomed to handling orders for printing. However, once steps necessary to handle this type of order are learned, one soon realizes the opportunity to not only serve a customer beyond their paper requirements, but an opportunity to improve even further the profitability of envelope orders.

Printed orders generate repeat business.

It is important for paper salespeople to understand the different printing processes utilized in the production of printed material and particularly in the production of envelopes. The more knowledgeable you are, the more you can be helpful to your customers assisting them in selecting the proper paper and envelope for the job.

Your knowledge of the printing process becomes particularly important when an envelope job is going to be printed by NATIONAL / WILLIAMHOUSE or under NATIONAL / WILLIAMHOUSE's direction for your printer or customer.

1. When you are communicating your customer's needs to NATIONAL / WILLIAMHOUSE, your customer will expect the proper printing process and quality they require. If you were to request flexography and the customer wanted offset printing, there is a possible rejected order. Least of all, you will have a very dissatisfied customer.
2. The cost differences between processes are such that if you were to ask for a quote using a lower cost process and the order was then placed for a more expensive process, you may find a profitable order will become a loser due to the increased cost of printing your order to satisfy your customer's requirements.

Remember!
**The better the artwork,
the better the print job.**

EMBELLISHMENT PROCESSES

Embossing

The company's printing plants maintain an array of presses for embossing before converting or after converting. Using your artwork, we will obtain the dies, provide a proof and run envelopes to your quality specifications.

Foil Stamping

We also maintain a variety of presses for flat foil stamping or a combination foil stamping/embossing. Depending on the artwork, foil stamping can be accomplished before or after converting.

Printing

We have the capability of printing up to 9 colors per envelope, with hairline registration, on our new state-of-the-art machinery.

Litho Converting

We can turn your flat sheets of paper that have already been printed, embossed, and/or foil stamped into envelopes.

Samples

The Corporate Sample Department can provide envelope samples of standard and non-standard envelope sizes and styles you require, along with printed samples, to demonstrate our capability and quality standards.

PRINTING

With the use of appropriate graphics, envelopes can enhance, reinforce and reveal important aspects of the enclosed message.

Most commercial printers have envelope feeding equipment to handle printing. Folded envelopes should be square, otherwise the printed image will vary in position and squareness to the outer edge. Large run printing can be accomplished by the envelope converter.

National and Williamhouse maintain their own pre-press and platemaking facilities. Artwork can be prepared for your order or we can make plates from your supplied mechanical to print. Or, the envelopes are printed, in blank form, in line during the conversion process or after the envelopes are folded. And we use water based environmentally safe inks in our printing equipment.

Our new state of the art Electronic Prepress system is on line, allowing us to offer an even higher level of quality and a broader range of services for your printing requirements. Our system includes:

- ☒ Computerized Workstations
- ☒ Scanners
- ☒ Computer RIP Station
- ☒ Imagesetter
- ☒ Laser Printer

OFFSET PRINTING

Offset Lithography offers the highest quality of envelope printing. It produces a clear, well-defined image area and provides excellent ink coverage. It is effective on many different paper surfaces from smooth vellums through laid, embossed finishes and heavily textured felts. Offset printing is generally done after the envelope is folded, but the blank can be printed before folding to allow for closer registration if the copy wraps around the sides of the envelope.

In preparing an offset plate from a negative, the image is burned through an emulsion on the plate and treated to provide a "greased image area". On press, the plate is first dampened with water, then ink rollers pass over the plate. The greasy image area accepts the greasy ink while the wetted area rejects it. The printing plate then makes contact with a canvas-backed rubber blanket that accepts the inked image and transfers it to the paper.

The offset process is ideally suited for printing envelopes because the rubber blanket helps to compensate for the bulk of varying paper thicknesses of the envelope.

FLEXOGRAPHY PRINTING

Flexography is a printing process in which the printing plate places ink directly on the paper. Printing is done from plates on which the image to be printed is raised above the non-printing surface. Ink is applied to the raised surface while the surrounding areas are lower and do not receive ink. The inked image is then pressed directly onto the paper.

High-Speed Flexography equipment uses flexographic inks that are water based for fast drying and environmentally friendly. When we print in-line on our envelope folding machines, there is very little time for the ink to dry before the envelope is folded. The use of these inks also provides excellent coverage of solid image areas and will not appear as glossy as traditional flexo inks.

At NATIONAL and WILLIAMHOUSE we use printing plates made from photo polymer material. We use the Pantone Matching System (PMS) for all of our printing.

INSIDE TINTS

NATIONAL/ WILLIAMHOUSE maintain many different tint styles, all of which are available to your customer. Inside tints are generally used to increase the opacity of the envelope in order to provide greater confidentiality for the material being carried. Tint designs are often used in direct mail to enhance the presentation.

Should your customer want a custom inside tint for example; including their company name logo, product or art, etc., this can be easily done. Simply have the customer provide us with original artwork or we can generate it. It is important at the time of quotation that we understand any need for a special tint.

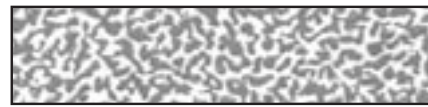

Mosstype

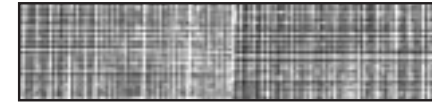

Linen

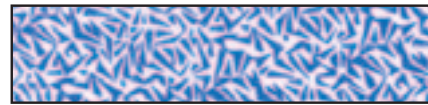

Barbary



Lines

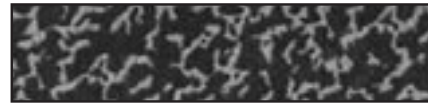

Krackle



Confetti



Woodgrain

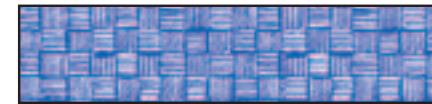

Basketweave



Aurora

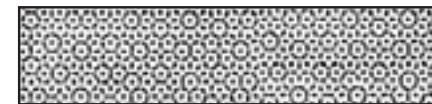

Sunburst

These are some of the many tint patterns available. Stocked pattern and color may vary by division.

LITHO CONVERTING

WHAT IS LITHO CONVERTING?

- Litho converting is a process in which a flat sheet of paper, which previously may have been printed, embossed and/or foil stamped, is converted into an envelope.

THE LITHO CONVERTING PROCESS- STEP BY STEP

- Step 1:** Request envelope layout from your local Paper Distributor. They will contact our closest location and send the printer an envelope layout including instructions.
- Step 2:** Read the instructions carefully and strip film according to layout. Before printing, furnish one complete full sheet blueline, along with the original layout furnished to printer. Send both items to us for approval.
- Step 3:** After blueline approval, print and send lithoed paper to our nearest designated converting plant.
- Step 4:** We will die cut, approximately 200 sheets per lift.
- Step 5:** Die cut blanks will then be fed into the folding machine for gumming and folding to a complete envelope. We will fold all blanks cut and invoice maximum yield possible.
- Step 6:** We will ship envelopes to customer as per order instructions from the Paper Merchant.

WHAT ARE THE BENEFITS OF LITHO CONVERTING?

- The creativeness of the finished piece is not limited because of printing capabilities on a ready made envelope.
- Bleeds, large solids, or full custom tints can be printed on coated or uncoated stock to enhance the appearance of the envelope.
- Foil stamping and register embossing can be done flat sheet without leaving a debossed image on the envelope.

More literature on Litho Converting is available through our corporate sample department.

TIPS FOR A SUCCESSFUL LITHO CONVERTING JOB

Tips for the Printer

Guide marks must be placed in the exact location indicated on our tailor-made press layout sheet for each envelope blank on the press sheet.

If a solid ink lay bleeds into the area containing the guide marks then reverse the mark in the solid.

If the printed bleed is a pattern or design, place the guide mark in the design where it can still be picked up by a trained eye but will not be apparent to the average viewer.

CAUTION: Without guide marks on the finished press sheets, it will be impossible or very expensive to attempt to register die cutting to printed images.

Trimming

Generally the full press sheets will be repacked in cartons or on skids for shipment to us. If, by prior agreement, the press sheets are to be split by the printer before shipment, it is essential that lifts be piled by cut. Each pile should be clearly marked and packed separately. It is also helpful to include with the shipment to us a full press sheet with the cuts, gripper and side guide clearly indicated.

Tips for the Printer and Designer

The more complicated or unusual your design, the more you need to communicate with us early in the concept phase while design adjustments can still be made. Incidentally, it's a good idea at some time to consult your local U.S. Post Office to be sure your design concept does not conflict with postal regulations.

Scheduling

Register of Design Elements Across Envelope Seams:

This is without question the most difficult register problem in converting envelopes. Whenever possible, avoid design concepts that call for an exact register of graphics across any envelope seam. Consult a National Envelope or Williamhouse expert early in the design stage and perhaps suggestions can be offered to provide the "look" you are after without an exact register across a seam.

Multiple Return Address: Litho converted envelope jobs that require many address changes need proper design planning. Jobs requiring address changes that register close to a logo or other printed copy and quantities for each are known, can be done by printing different versions that are properly marked. However, some clients require logo "shells" printed flat sheet and converted to be overprinted with address changes at a later time. These do not make good litho converting jobs. Due to

converting variance, copy on the envelope will move up to 1/8". Trying to register address copy on a printed piece after the envelope is converted is risky at best. Jobs requiring overprint after envelope conversion should be designed so that the address is on the back flap, not registered next to the logo or copy on the face.

Bleeds

For the sake of simplicity, we will use a #10 Commercial envelope for the following illustrations to define proper terminology:

Full bleed: Ink is to cover entire visible front and/or back of envelope. The printed image must extend 1/8" beyond the die cut edge of the envelope to insure full coverage in the final envelope. When an envelope will appear to be fully covered with ink, our press sheet layout will indicate void areas in the envelope blank which should not be printed. These voids will be areas to which envelope adhesive will be applied.

Partial bleed: Ink coverage indicates that the printed image extends over part of a fold off part of an edge of the envelope blank. It is difficult to die cut and fold envelopes in hairline register with printing. We suggest the graphics be designed to print over the envelope fold and on to the back of the envelope by 1/8".

Printing/Tinting: Solid or screen coverage on inside of envelope. Full coverage, line or screen images (tinting) on the inside of the envelope, offers several benefits. The inside printing particularly in White Wove Commodity envelopes increases the opacity of the finished envelope. Personalized tints incorporating company logos provide added security and prestige. Tinting has become associated with envelopes containing confidential information such as bills, checks, policies, etc., and therefore can be used as a design technique on any style envelope or paper for increased impression value. Full ink coverage can add richness to the presentation of the material contained. However, the use of a full coverage of darker ink colors may show through the envelope paper, detracting from the appearance.

Printed image: Printed on front of envelope, not touching a fold. The printed image should be at least 1/8" from any fold. Avoid printing in address, postage and bar code areas of envelope front. Consult your local Post Office for guidelines and regulations.

LASER PRINTING FACTS

- Most laser printers have feeding mechanisms designed for single sheet applications. Envelopes are sheets of paper cut and folded into multi-thicknesses. Each printer model may produce different results, larger volume models usually handle envelopes better than smaller desk-top models. Commercial design envelopes are best suited for laser applications.
- MOISTURE is the true enemy of laser printers when running envelopes. Premature sealing is caused by a moisture build-up inside the printer when heat from the fusion chamber evaporates moisture in the paper and/or the air.
- Most envelopes have at least three thicknesses of paper. It is advisable to specify a paper that has a caliper thickness that facilitates the fully closed envelope passing through the paper path of the laser printer. Generally, substance 24 paper is the most compatible for use in laser printing equipment.
- Commercial flap and diagonal seam envelopes perform the best.
- Value-added operations such as thermography, offset printing, and embossing may affect the envelope feeding process.
- Since moisture (*high humidity of 60% or higher*) is an enemy of laser printers, it is recommended that envelopes be stored in a cool, dry location (*40% to 50% relative humidity*).
- Never use a poly or cellophane window in a laser printer.

WHAT TO LOOK FOR IN A QUALITY ENVELOPE:

In this section you will find:

- How to identify a quality envelope
- How superior envelopes are created.
- Straight-grain vs. diagonal-grain
- Order Checklist

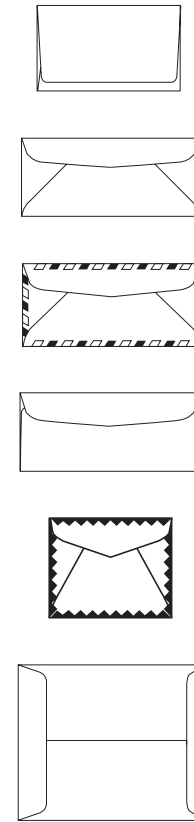

ORDER CHECKLIST

We can help you obtain the best results for your envelopes by following this checklist when ordering:

- Envelope size and style
- Type of stock (grade, weight, color, finish)
- Window size, style, position and window patch material (if a window is needed)
- Quantity of envelopes required
- Description of Enhancement (or Embellishment) method including:
 - ☒ Full coverage/heavy coverage
 - ☒ Bleed
 - ☒ Reverse print
 - ☒ Perfecting (printing on sealing flap or back side as well as front)
 - ☒ Close registration
 - ☒ PMS Color(s)
 - ☒ Tinting inside
 - ☒ Sample, artwork or negative to be supplied
 - ☒ Delivery requirements
 - ☒ Color of foil needed for stamping or embossing
 - ☒ Blind embossing
 - ☒ Litho Converting

HOW SUPERIOR ENVELOPES ARE CREATED

We are dedicated to the task of manufacturing superior quality envelopes, announcements and related accessories. Every single envelope that we manufacture — from the broad offerings of over 30 leading paper mills — is perfectly squared, precisely sized and smoothly tapered.

WHAT MAKES A QUALITY ENVELOPE?

There are real quality differences in envelopes that affect their functionality. With the increased demand in laser printing applications, the use of automatic insertion equipment for bulk mailings and the growth in postage meters for business, a well-engineered envelope that can withstand multiple downstream applications is more critical than ever. **Here's what you should look for in evaluating the quality of an envelope, no matter what job your envelope was created for:**

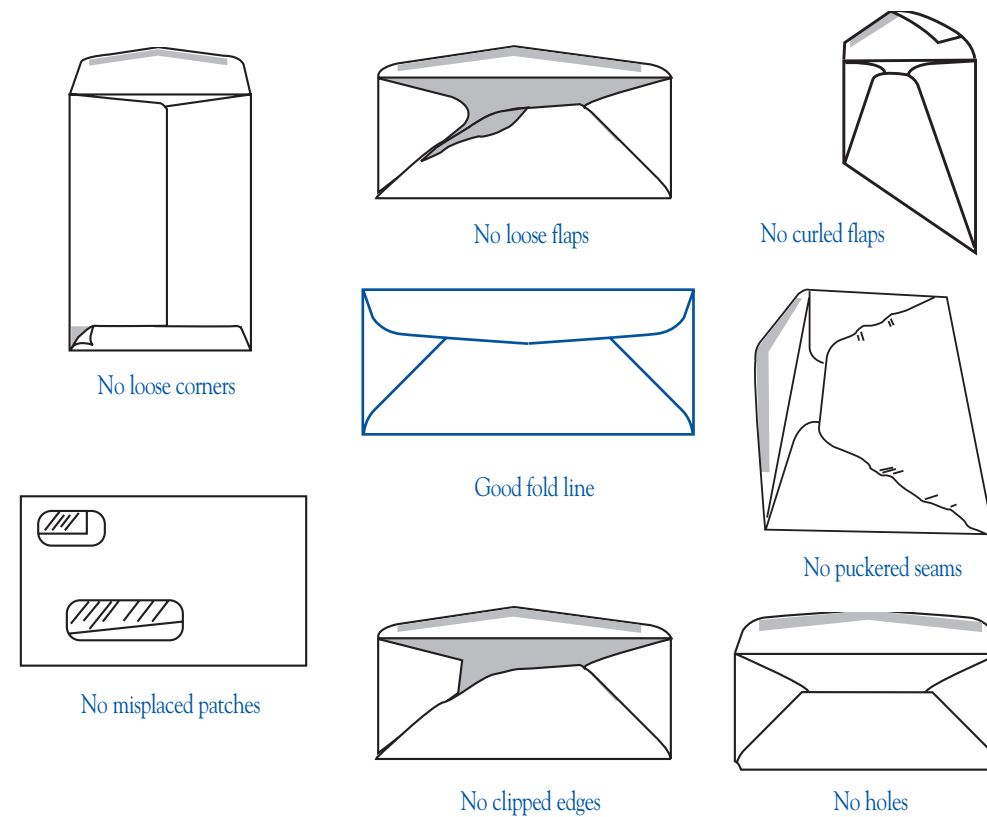

AN ENVELOPE THAT DOESN'T GET ATTENTION GETS TOSSED

An envelope is a potential customer's first impression of your company. It is a powerful communicative tool that speaks to the recipient even before the envelope is opened. The envelope should not be an after-thought in the design process. It should be created when a project is conceived for maximum value.

WHAT TO LOOK FOR IN ENVELOPES

National and Williamhouse uses envelope adhesives that stick quickly and strongly upon remoistening, and resist tacking when exposed to normal humidity. Our envelopes perform well in most large printing units. Here is what to look for:

- Envelopes that are manufactured square and straight.
- Envelopes that are constructed tightly to improve performance and avoid jamming.
- Envelope folds which are sharply creased to avoid feeding problems.
- Envelopes without synthetic material, windows (except glassine material), clasp closures or snaps. These items should not be run through a laser printer as they may cause severe damage to the printing unit.

National Envelope Corporation and Williamhouse are committed to converting the finest quality envelopes in the business. You can specify with confidence the use of our envelopes in laser printers.

POSTAL REQUIREMENTS

In this section you will find:

Some of the most recent guidelines from the U.S. Post Office for business mailings.

- Clear Zones
- Barcoding
- Envelope Mailability with Template
- Automation
- FASTforwardSM
- QBRM
- Merlin
- Automatic Inserting
- Sources for more information

(Note: All postal and mailing regulations subject to change without notice. Please verify prior to printing and mailing.)

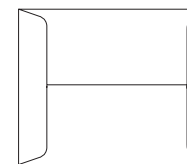
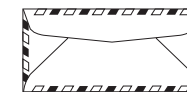
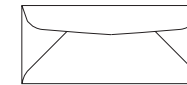

POSTAL REQUIREMENTS

POSTAL REQUIREMENTS

The U.S. Postal Service establishes and publishes in the [Domestic Mail Manual \(DMM\)](#) an extensive list of requirements with which business mailings must comply. These requirements determine (among other things) acceptable envelope sizes, position and sequence of address lines, graphic restrictions, and mandatory “clear zones”.

The DMM is available in two formats: paper and electronic.¹

The electronic version of the DMM is available in two formats: on the Internet and on an interactive CD-ROM. The internet address is <http://pe.usps.gov>, where the DMM is updated monthly.²

While it is impossible to list all the requirements, here are a few which should prove helpful. Consult with your local Postmaster where envelopes will be mailed from, on any additional questions you may have.

Clear Zones

- When the envelope is addressed with a name, address, and zip code, the Post Office will read the zip code with an [OCR \(Optical Character Reader\)](#) and print a barcode on the envelope in the lower right hand corner. This is why you must keep a “clear zone” on the lower right hand corner of the envelope (now $\frac{5}{8}$ " up from the bottom and $4\frac{3}{4}$ " out from right edge).

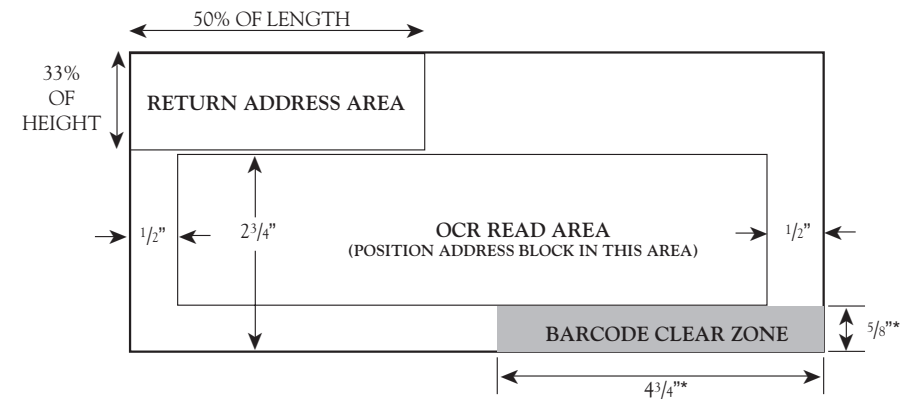

*Standard stocked window envelopes now provide 1/2" clearance. The Postal Service recommends allowing 5/8"

Barcoding

- The Post Office has recently found a way to more completely automate letter sorting in first, second and third class mail. This involves the software to transform a Zip+4 zip code into a larger barcode, called a [Delivery Point Barcode \(DPBC\)](#), which designates a specific city block, an apartment house, or even a particular floor in a large office building.

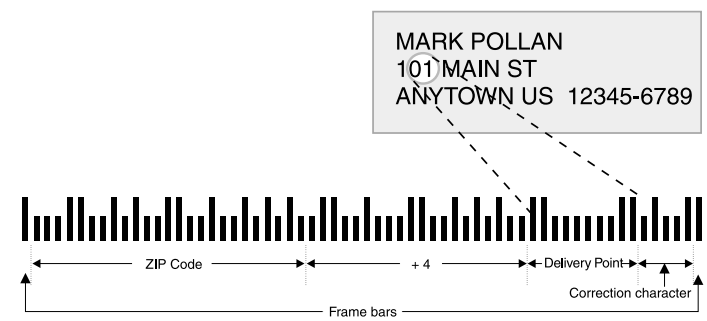

- This coding enables the automatic sorting of mail exactly to a carrier's delivery route, eliminating time consuming hand sorting by as much as 50%. This new, larger barcode is the basis for the new postal requirements for a larger “clear zone” (from $4\frac{1}{2}$ " to $4\frac{3}{4}$ " out from right edge in the lower right hand corner of the envelope when the mailer does not put the barcode on himself). Mailers must develop the capability to put their own expanded barcode on those pieces of mail that they barcode themselves. They are not allowed the pre-sort discount associated with barcoding unless they comply with the new expanded barcode guidelines.

- If a mailer is applying his own barcodes to an address block to be shown through the envelope window, care should be taken that the window is large enough so that the barcode is clear of the edge at least 1/8" left and right and 1/25" top and bottom, no matter where the piece moves inside the envelope. Therefore, some windows may need to be expanded to accommodate the new, larger barcode.

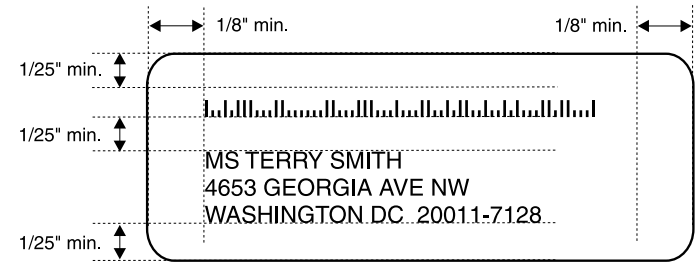

- If the mailer has the software to print a barcode along with the name, address, and zip code, either directly above or directly below the name, address, and zip code, or showing through a window, then there is no need to maintain the “clear zone” on the lower right hand corner of the envelope since the Post Office will not be printing the barcode. Therefore, you won’t have any restrictions on the graphics you can apply to your outer envelope, as long as you leave the needed clear space around the barcode itself.

Exceptions:

- If the mailing piece weighs more than one ounce, there will be no surcharge for the envelope size.
- If the piece is sent third class, there will be no surcharge for a single piece weighing one ounce or more.

Automation

- Because the costs of processing mail are steadily increasing, the use of automation is the logical choice for improving productivity and reducing expenses. Sorting 1,000 letters through automation saves up to \$45 compared with processing the same mail by other, less efficient methods.⁵
- The Postal Service uses a variety of automated equipment. The most efficient and accurate mail processing results from using automated, high-speed, computerized mail sorting and processing equipment. The Postal Service uses two basic types of automated equipment to process letter-size mail.⁶

Multiline Optical Character Reader

- A multiline optical character reader (MLOCR) scans the address block on each letter-size mailpiece to determine the ZIP+4 code and the delivery point information. The MLOCR verifies the address information against an internal database.⁷
- MLOCRs are capable of reading, barcoding, and sorting mail at a rate of 40,000 pieces per hour—about 11 pieces per second. These machines are used not only by the Postal Service but also by large companies and collateral mailing agents like presort bureaus and letter shops.⁸
- If you accurately barcode your letter-size mailpieces, they can skip the entire MLOCR process and go straight to a barcode sorter. Mail in this category can receive the maximum postage discount.⁹

Barcode Sorter

- A barcode sorter (BCS) “reads” POSTNET barcodes on letter-size pieces and sorts the mail accordingly. This machine doesn’t read addresses, so it will missort a piece if the customer has applied an incorrect barcode. The BCS can read and sort 40,000 pieces per hour as well.¹⁰
- POSTNET (Postal Numeric Encoding Technique) is the USPS-developed barcode method to encode ZIP Code information on mail that can be read for sorting by automated machines.¹¹

ENVELOPE MAILABILITY TEMPLATE

You do not need to be a wizard at math, you can use this handy chart as a quick guide for your envelopes mailability.

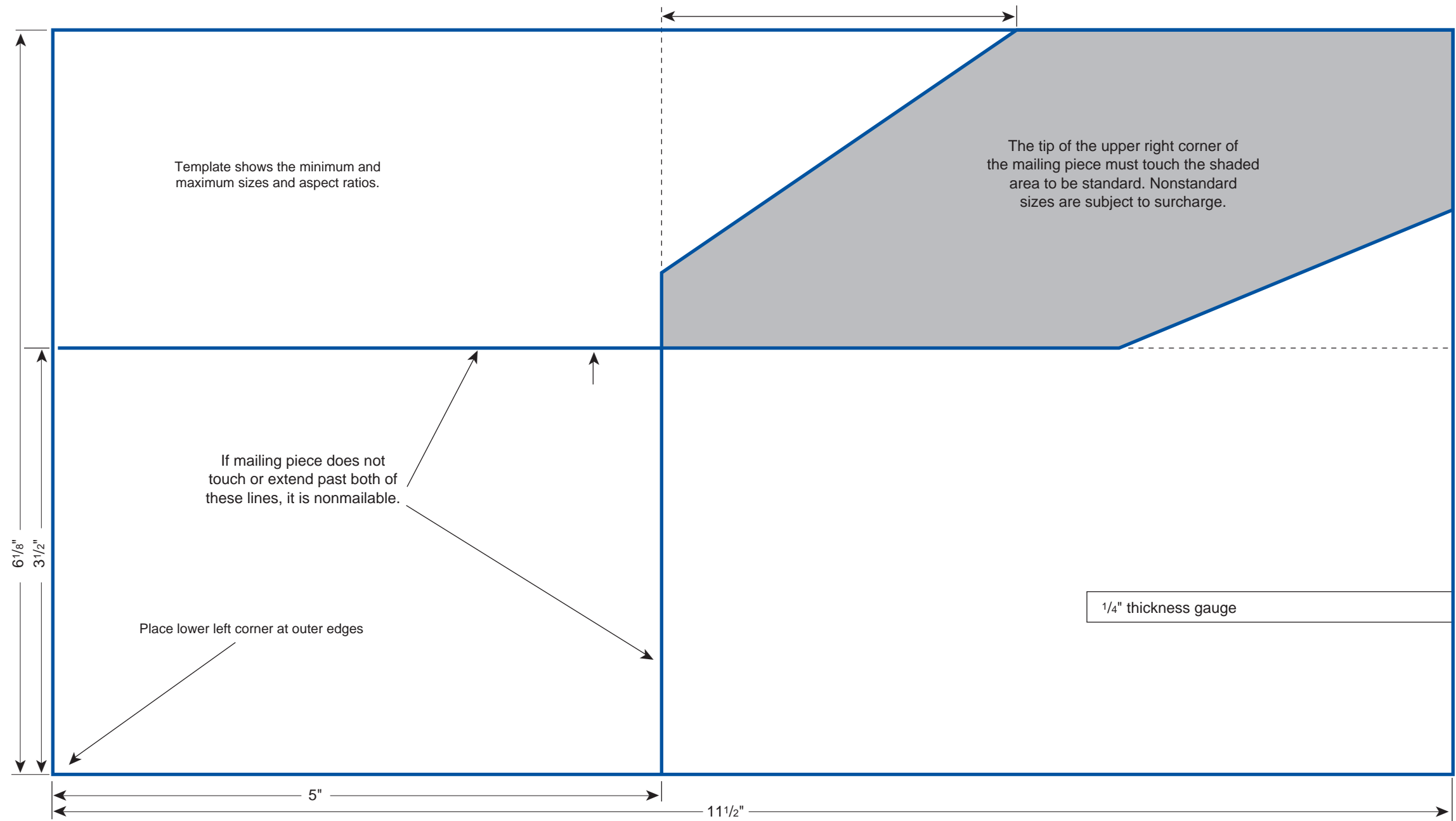

Envelope Mailability

To avoid a surcharge:

- The minimum size must be 3 1/2" x 5".
- The maximum size must be 6 1/8" x 11 1/2".
- The maximum thickness is 1/4".

This template shows the minimum size mailing piece which will be accepted and the dimensions which are subject to surcharge for first- or third-class pieces weighing up to one ounce.

The aspect ratio of a mailing piece (the length divided by the height) should fall between 1.3 to 1 and 2.5 to 1. For example, a #10 envelope is 4 1/8 x 9 1/2. The aspect ratio is 2.3, so the envelope is mailable.

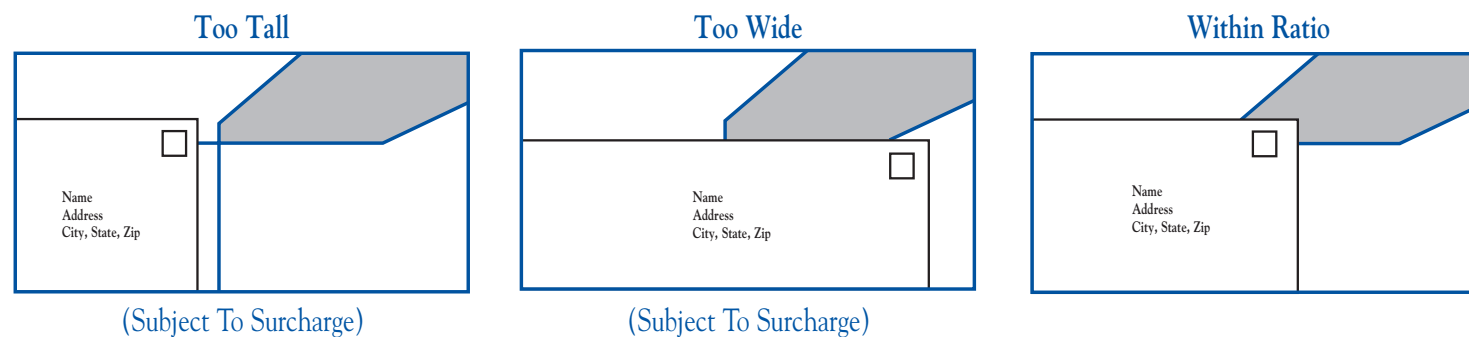

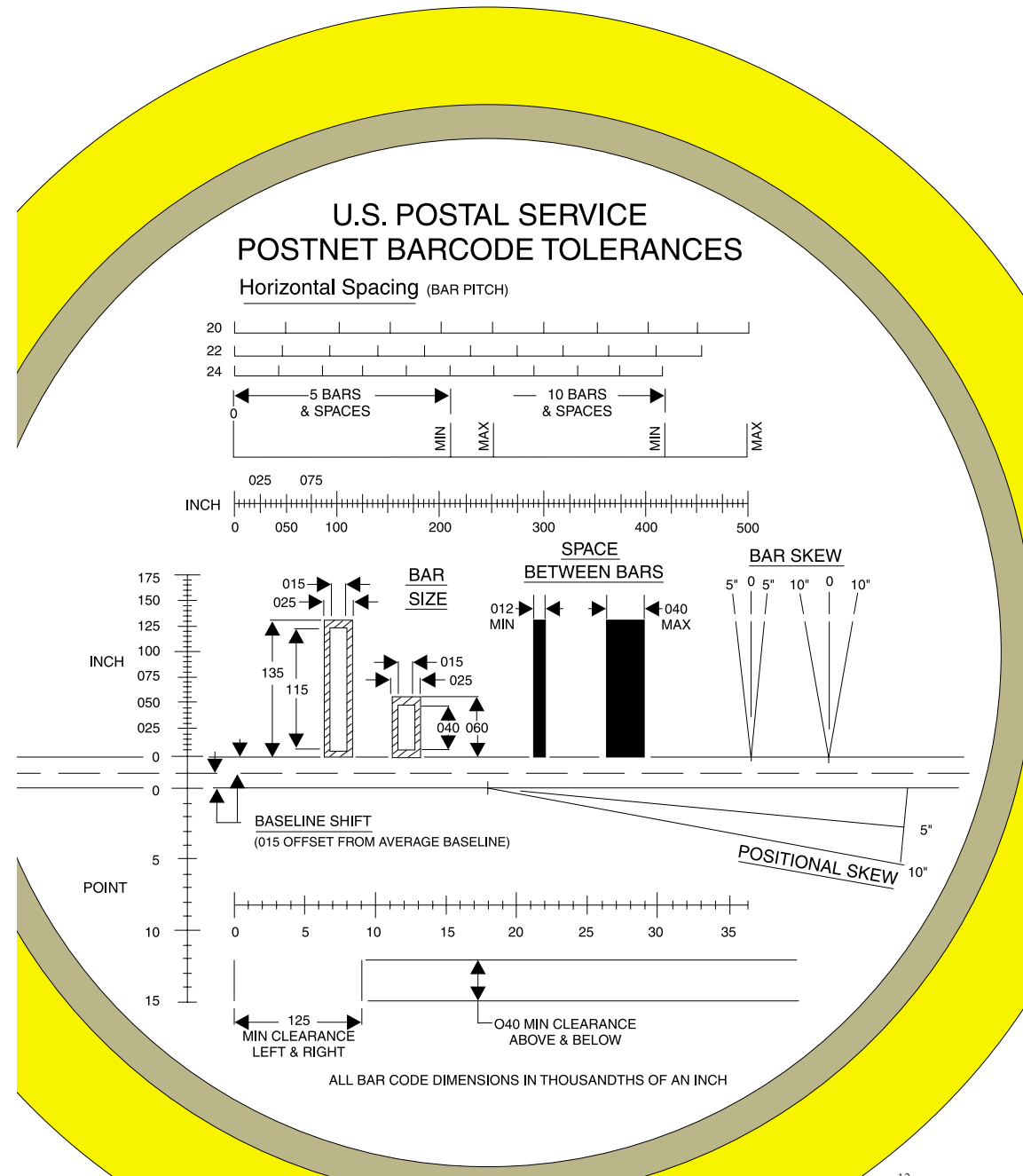

12

FASTforwardSM

- The FASTforwardSM system contains more than 16 million permanent [change-of-address \(COA\)](#) records filed with the Postal Service by relocating customers who have their mail forwarded to their new address. These COA records reflect a six month period related to the move-effective date the customer provided. [The FASTforwardSM COA data is updated weekly.](#)
- The **new** address supplied by the relocating Postal customer must be ZIP+4 codeable to qualify for addition to the FASTforwardSM file. All customer addresses submitted to a FASTforwardSM client are processed by [Coding Accuracy Support System \(CASS\)](#) certified ZIP+4/DPC Licensee software and coded where possible. However, **new address** (forwarded to) information is provided **only** when a FASTforwardSM **match** to the customer name and address is attained. The provision of COA information is controlled by strict name and address matching logic.

FASTforwardSM Versions

Multi-line Optical Character Readers

- The original FASTforwardSM application was developed to interface with commercial mail-processing equipment, such as multi-line optical character readers (MLOCRs). Any new address provided by FASTforwardSM as a result of a match is appended with the ZIP+4/DPC information along with a text representation of the new (forward to) delivery address. This returned information is sprayed on the mailpiece in the barcode clear zone by the MLOCR system.
- Space must be provided on the envelope for the two lines of the new address to be sprayed on the mailpiece. **The window of an envelope for the two lines may not be lower than 5/8" from the bottom.** The advantage is that the mailings can continue to be mailed at discount rates. The disadvantage is that no move update information is returned to the mailer. To get this information, the mailer could have a separate set of cards run through the system to get back the new address.

Computer-Based

- The second version, FASTforwardSM for database correction, provides FASTforwardSM Licensees the ability to update computer-based name and address databases electronically prior to the creation of the mailpiece. This version also requires Licensees to have a FASTforwardSM interface that meets Postal Service specifications. In the event that a new address information is returned, the effective date of the move and the carrier identification for the new address are also returned. This returned information is used to update the database.

Licensees

- The FASTforwardSM system consists of a licensed computer system containing FASTforwardSM name-and-address-matching software and the COA database. The Postal Service is the sole owner and distributor of the FASTforwardSM hardware and software components that comprise the FASTforwardSM system. Specifically, this includes the x software, the computer system itself, and the small computer systems interface (SCSI) integrating cable that connects the x systems to the Licensee-owned or -leased system components. The FASTforwardSM system is sole property of the United States Postal Service © 1996, All rights reserved. Moore Business Communication Services and Moore Response Marketing Services are nonexclusive Licensees of the United States Postal Service. The price at which FASTforwardSM services are being offered by the Licensee is neither established, controlled, nor approved by the USPS.

Participating in Qualified Business Reply Mail

- QBRM provides an automated method for sorting, counting, and rating BRM. The processing of your mail on automated equipment presents an excellent opportunity for increasing efficiency, improving service, and protecting postal revenues.¹³
- Besides meeting the standard BRM format requirements, you must meet the following additional QBRM requirements:
 - Prebarcode your QBRM pieces. You are assigned a unique ZIP+4 code and corresponding barcode that identify the customer and the category of mail.
 - Use FIM C. A camera-ready positive is available at no charge from the Postal Service.
 - Provide samples of your BRM pieces to a mailpiece design analyst early in the design process. To make sure that your pieces achieve the best quality, allow time for changes before printing.¹⁴

MERLIN

- [Mail Evaluation, Readability and look-up Instruments \(MERLINS\)](#) will automate mail acceptance procedures in [Bulk Mail Entry Units \(BMEU\)](#) and shorten mail verification time.
- MERLIN can simultaneously handle verification functions, which have been performed manually. It will verify mailpiece characteristics, meter identification and date, endorsements and rate markings, barcode readability, address accuracy, tray label accuracy, Carrier Routes, Presort makeup, weight and piece counts.
- Diagnostic reports are automatically generated and customers' mailing information can be stored electronically for later retrieval.
- MERLIN will provide customers feedback to help improve mail preparation to qualify for discounts. The automated system is capable of evaluating both letter and flat mail (6,000 letters or 4,000 flats per hour).¹⁵

AUTOMATIC INSERTING

It is critical that you choose an envelope for inserting that is compatible with the inserting equipment that will be used. Each manufacturer of inserting machines provide carefully defined specifications for the style and type of envelope which will perform well on their equipment. We recommend contacting the inserting machine manufacturer prior to specifying your envelope to be sure you are selecting the correct style for accurate inserting performance.

Basic guidelines for best performance. Verify with inserting machine manufacturer before selecting your envelope:

- ☒ Always specify “for mechanical insertion” when ordering envelopes.
- ☒ Stock may range from 20 lb. to 28 lb., 24# is optimum.
- ☒ Envelopes made from recycled stock should not have a shiny or slick surface.
- ☒ Minimum flap size is 1 1/4” - Maximum flap size is 2 1/4”.
- ☒ Whatever the size of the enclosure, add 1/2” to the length of the envelope and 1/4” to the height.
- ☒ Split-seal gumming on diagonal seam envelopes prevents the flap from tacking down to the body of the envelope.
- ☒ Window patches should be glued to within 1/16” from the top edge of the patch material and window cutout.
- ☒ Samples are available and suggested for testing on your insertion equipment.
- ☒ Open window envelopes will require an open window kit.
- ☒ When utilizing a regular gummed postage stamp, specify “*For Live-Stamp Gumming*”.

NATIONAL/ WILLIAMHOUSE and your local paper supplier are available to answer any questions or concerns you may have regarding mechanical inserting.

Sources for More Information

Because there are unusual exceptions in all classes of domestic and international mail, and because regulations change, contact the U.S. Postal Business Center in your city for the most current information.

For Small to Medium Business Mailers

Postal Business Centers are located around the country: their primary focus is to improve service and to assist in converting the mail to be conducive to automation. Among the services offered:

- Adding ZIP+4 codes to address files including a one time free U.S.P.S. diskette coding service
- Diagnosing Business Reply and Courtesy Reply envelopes and cards for readability and machinability
- Postal products services and information

Call your post office for more information.

Mailpiece design analysts (MDAs) are assigned to business mail entry units (BMEUs) throughout the country to help you design your reply mail. To make sure that your piece achieves the best quality, provide samples of your BRM or CRM pieces to an MDA early in the design process, allowing time for changes before printing.¹⁶

Zip+4 address lists

Printed ZIP+4 code state directories can be purchased at a nominal cost from local post offices.

Artwork

For free FIM and bar code positives for Postage-paid reply, Business Reply Mail and for Courtesy Reply Mail contact your local Postal Business Center.

¹Designing Letter and Reply Mail, Publication 25, March 2001, Introduction, p.1 ¶4.

²Ibid, p.1 ¶5.

³Designing Letter and Reply Mail, Publication 25, March 2001, Chapter 4 - POSTNET Barcodes, Exhibit 4-1 Delivery Point Barcode, p. 38.

⁴Designing Letter and Reply Mail, Publication 25, March 2001, Chapter 2 - Automation Design Standards, Exhibit 2-6 Barcode/Window Clearance, p. 20.

⁵Designing Letter and Reply Mail, Publication 25, March 2001, Chapter 2 - Automation Benefits, p. 3 ¶1.

⁶Ibid, p.4 ¶6.

⁷Ibid, p.4 ¶7.

⁸Ibid, p.5 ¶1.

⁹Ibid, p.5 ¶2.

¹⁰Ibid, p.5 ¶3.

¹¹Domestic Mail Manual (DMM) C840.1.1 Barcoding Standards for Letters and Flats. Issue 57 plus Postal Bulletin changes through PB 22095 (2-6-03), p. C-95 ¶2

¹²Designing Letter and Reply Mail, Publication 25, March 2001, Chapter 1 - Automation Benefits, Exhibit 1-3 POSTNET Code Eyepiece with Reticule, p. 9.

¹³Designing Letter and Reply Mail, Publication 25, March 2001, Chapter 6 - Business Reply Mail, p. 79 ¶1.

¹⁴Ibid, p.80 ¶7.

¹⁵Merlin Presentation 2002, p. 2.

¹⁶Designing Letter and Reply Mail, Publication 25, March 2001, Chapter 5 - Reply Mail, p. 57 ¶5.

GLOSSARY & INDEX

In this section you will find:

- A glossary of terms commonly used in the envelope industry.
- An alphabetic listing of envelope related topics to help you quickly find the information you're looking for.

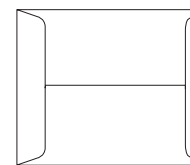
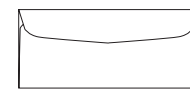
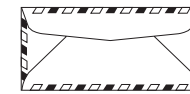

**GLOSSARY &
INDEX**

GLOSSARY OF ENVELOPE TERMS

Listed below are the most widely used terms in the envelope industry. It is recommended that you familiarize yourself with these terms.

ABSORPTION:	A property of paper; absorption is the ability of paper to take up liquids or vapors. This plays a key role in the quality of the bonding process of the adhesives used to manufacture an envelope, and in the storage process as the stored envelopes are subjected to humidity.
ADHESIVES:	There are two main groups of adhesives used to manufacture an envelope. The first group consists of fastening agents used to bind the seams of the envelope together permanently. The second group includes the various sealing agents used to bind the seal flap to the back side of the envelope.
ADJUSTABLE DIE:	Device designed to cut envelope blanks utilizing a system of movable blades. This is a cost effective way to produce small, odd-size runs where the only alternative is purchasing a new high die.
AIR MAIL ENVELOPE:	A light-weight envelope with red and blue border and "Air Mail" printed on the face, specifically designed for keeping the cost of postage down by reducing the weight of the mailing.
A-STYLE ENVELOPE:	Announcement style, open side envelope with double side seam construction and a square flap. Available in six standard sizes and most often converted from text paper.
BACK GUM:	Also called seam gum. It is the adhesive used to seal the seams on the back of the envelope to form the envelope pocket.
BANDING:	A counting method in which a paper band is placed around a specific number of envelopes. Most commonly used for greeting envelopes.
BANKERS FLAP ENVELOPE:	Also known as a wallet flap, this envelope is readily available in the larger commercial envelope sizes and is used for heavy mailing applications, such as bank statements that must get through the mail system intact and secure.
BARONIAL:	Often used for announcements and greeting cards, this envelope has a large pointed flap and diagonal seams, and is available in five popular sizes. Companion panel and plain cards and folders are readily available in the standard sizes.
BASIS WEIGHT:	The weight of 500 sheets of a standard size paper of a given grade. For example, 500 sheets of a 25 x 38 Basis 80 text paper weigh 80 pounds. In another example, 500 sheets of 17 x 22 Substance 24 bond or writing paper weigh 24 pounds.
BLANK:	The die cut paper in the form of an envelope prior to folding.
BLEED:	When the printed image extends beyond the fold of an envelope or off the edge of an envelope blank.
BLOCKING:	The premature activation of the front seal gum in areas other than those directly above the back seam gum.

BOOKLET:	An open side, double side seam envelope, usually having a wallet style flap. This envelope comes in many standard sizes. The most popular size is 9 x 12.
BOTTOM FLAP:	The section of the envelope folded up from the bottom score to form that portion of the back of an envelope.
BANG TAIL:	A booklet style envelope with an extension on the bottom flap that is "perfed" at the throat. This extension, or tail, is usually printed as an order form. Bang tail envelopes are commonly used by mail order companies and as credit card statement remittance envelopes.
BUSINESS REPLY OR RETURN ENVELOPE:	These envelopes can be any style or size. The distinct difference is "Who pays the postage?" A BUSINESS REPLY is pre-printed with a first class permit and return address in which the original sender pays for its return. It is commonly referred to as B.R.E. The BUSINESS RETURN has a pre-printed return address, but the individual returning the envelope must apply postage. The most commonly used envelopes for either purpose are the commercial style-sizes 6 1/4, 6 3/4, #9.
CATALOG ENVELOPE:	An open end center seam envelope with the seal flap on the short dimension. Catalog envelopes with a single side seam are not commonly used, but are available upon special order.
CENTER SEAM:	Most common on open end envelopes, this is the permanent seam that joins the two side flaps together at the center of the envelope, running from the bottom of the envelope to the throat of the envelope.
CLASP ENVELOPE:	Almost always made from an open end envelope, a clasp is secured to the back side of the envelope with a small reinforced hole punched in the flap for the clasp to slip through and be secured. The flap is usually gummed. The clasp can be used for added security if the seal is activated, or can be used repeatedly if the gum stays inactive.
CLOSURES:	Various methods of securing the seal flap to the back of the envelope. STRING-AND-BUTTON: A string is affixed to the outside of the seal flap that the user winds around a disc that is affixed to the back of the envelope directly below the flap. Most commonly used on an inter-office envelope. LATEX: A self-sealing adhesive that requires no moisture. Latex gum is applied to the seal flap and to the back flap where the seal flap touches when closed. When the two latex gummed surfaces are pressed together, a bond is formed, holding the seal flap to the body of the envelope. REMOISTENABLE SEAL GUM: Commonly referred to as regular gum. Requires moistening to achieve a seal. There are two main types of seal gum. They are dextrine, a natural vegetable bi-product, and resin, a synthetic substance. Most remoistenable gum used today is a mixture of the two types. METAL CLASP: A winged metal device that is affixed to the back of the envelope just below the throat and behind the seal flap. It is bent open by the user, inserted through a reinforced hole in the seal flap, and bent back down to temporarily close the envelope.

PEEL & SEEL®: This closure consists of a "super sticky" gum line applied to the seal flap that is covered by a strip of release paper. The extremely aggressive nature of this adhesive creates a very secure closure.

TAC-N-TAC: A re-sealable closure consisting of a clear vinyl tape affixed over a hole punched into the seal flap. Another piece of release tape is affixed to the back of the envelope below the throat and behind the flap. When the seal flap is closed, the tape exposed through the hole and the seal flap adheres itself to the release tape on the back of the envelope. This closure can be sealed and re-sealed many times. It is used as an alternative to the button and string closure on inter-office type envelopes.

- CELLO:** Super clear cellophane window patch material. More costly than poly.
- COIN ENVELOPE:** A small open end envelope ranging in size from a #00 -11/16 x 2 3/4 to a #7 -3 1/2 x 6 1/2.
- COMMERCIAL STYLE:** Open side, diagonal or double side seam envelope with a commercial style flap. The most popular envelope for business, it is sometimes referred to as an "official" envelope. It is readily available in many paper varieties and comes in 11 common sizes, with or without a window.
- COMMODITY ENVELOPE:** Envelopes usually mass produced in standard sizes from open line papers, such as white wove and brown kraft. They are available for all customers of record to purchase.
- CONVERTING ONLY:** Paper is supplied by the customer for conversion into envelopes.
- COUPON HITCH-HIKER:** A remittance envelope with a perforated coupon extending from the flap, and a perforated tail extending from the back flap.
- DIAGONAL GRAIN CUTTING:**
The grain of the paper runs diagonally across the face of the envelope (corner to corner). Also known as cross grain or random cutting.
- DIAGONAL SEAM:** A seam running diagonally from the bottom fold and comes upward toward the throat of the envelope.
- DIE:** In envelope making, this term usually refers to a high die for cutting envelope blanks or a window die for cutting a window opening.
- DIE-CUT:** A process of cutting envelope blanks utilizing a high die.
- DOCUMENT ENVELOPE:** Sometimes referred to as legal envelopes, these are large, open side, double side seam outside, hex flap envelopes produced from heavy manila or brown kraft stock with heavy seal gum, used for mailing and storage of documents requiring security and confidentiality.
- EXPANSION ENVELOPE:** Much like a grocery bag. The gussets in an expansion envelope allow it to be expanded to accommodate such things as books, binders, manuscripts, and countless other bulky items. They are made in both open end and open side styles, most commonly of 40 lb. Kraft paper.

EXPANSION SCORE:	An additional score on a seal flap, running its length in order to accommodate bulk contents
ENVELOPE PRINTING:	<p>FLEXO OR LETTERPRESS: Good quality. Raised type on rubber or polymer plate. Uses aniline inks.</p> <p>DRY OFFSET: Better quality. 120 line screen maximum. Oil or rubber based inks.</p> <p>WET OFFSET: Best quality. 150 line screen maximum. Oil or rubber based inks. Includes flat sheet lithography.</p> <p>JET' OFFSET: High speed imprinting of folded envelopes. 2 color, 2 sides. Tight registration at speeds of up to 60,000 impressions per hour. Allows for fast turnaround on printing of stock envelopes.</p> <p>CORNER CARD: Printing of return address, logo, etc. in upper left hand corner.</p> <p>INDICIA: Printing in upper right hand corner of an envelope indicating that sender will pay postage.</p> <p>TINTING: Patterned printing on inside of envelope for added opacity and security. Corporate logos are commonly used in custom tints.</p> <p>CAMERA READY ART WORK: Professionally produced black and white layout of exact copy to be printed. This includes all typesetting and/or logo art. This is photographed in order to produce a negative for plate making.</p> <p>COLOR SEPARATED ART WORK: Each color requires its own art work for producing negatives and plates.</p> <p>PANTONE MATCHING SYSTEM (PMS): A book of standard ink colors and various shades of each, which are used to match and identify the colors of pre-printed samples. It is a universal ink matching system put out by Pantone Ink Company.</p> <p>NEGATIVE: Produced from the art work and is used to "burn" the image to be printed onto the printing plates.</p>
FILE-VELOPE:	A large, open side envelope, without a flap, which has inside side seams and a short tab at its opening. Generally used as a file pocket.
FIRST CLASS MAILER:	Any type or size of envelope with a pre-printed diamond shaped border around its perimeter. A break in the border is left in the upper right hand corner on the face of the envelope to accommodate postage and eliminate interference of postal scanners. The words "FIRST CLASS" are normally pre-printed on the face and seal flap, but are not required. The most common color used in printing is green, but most any color can be used.
FLAPS EXTENDED:	A term used to describe a request to have envelopes produced and packed with their flaps open and extended.
FLUSH CUT:	The seal flap is removed, leaving a straight opening at the top of the envelope.
FOIL LINED:	The inside of the flap and throat are lined with a decorative foil. Used most often in greeting cards.

FOLD:	Any folded edge of the envelope. Generally referred to as the side, top, or bottom fold.
GUM:	Any type of adhesive or glue used in the manufacturing of envelopes.
GUM SLING:	A term used to describe a manufacturing problem caused by back gum applicators splattering gum onto other surfaces of the envelope resulting in consecutive envelopes tacking or sticking together.
GUM SEEPAGE:	A term used to describe a manufacturing problem caused by an excessive application of back gum resulting in consecutive envelopes sticking together at the seam or the inside pocket of the envelope being stuck closed at the seam(s).
HITCH-HIKER ENVELOPE:	A dual-purpose envelope for use in both outbound and return response mailing.
INDICIA:	Mailing permits that are printed on an envelope where a stamp would normally be placed.
INTER-OFFICE ENVELOPE:	Usually an open end or catalog style envelope which is preprinted on both sides with lines depicting the person(s) and department that the envelope is to be delivered to. On a standard 10 x 13 size there are enough spaces to accommodate 56 deliveries. Eight 3/8" holes are drilled completely through the envelope for visible conformation of any contents. Button and string or Tac-N-Tac closures are used on this type of envelope.
JOB JACKET ENVELOPE:	A large envelope in which all aspects of a print job are kept for reference.
JUMBO ENVELOPE:	A very large envelope of either open end or open side construction. Ranging in size from 9 x 16 to 24 x 36 which can be machine folded to even larger sizes, which must be hand folded. Most super size envelopes are constructed of 28 lb. to 40 lb. Kraft paper.
LAYOUT:	In envelope making, a diagram showing the position of blanks on the sheet size to be utilized for a job. A layout is provided to allow a printer to strip his job up so as to have the printed image fall within the area from which the envelope blank is to be cut.
OPEN END:	An envelope term describing an envelope with the seal flap on the shorter of the two dimensions.
OPEN PANEL:	A term used when any envelope with a window does not have any type of clear window patch material affixed over the window opening from inside the envelope.
OPEN SIDE:	An envelope term describing an envelope with the seal flap on the longer of the two dimensions.
POLICY ENVELOPE:	An open end style envelope with the same dimensions as a #10 through a #14 commercial envelope.
POLY:	Polyclear window patch material, the most common window patch material.

PROXY ENVELOPE:	A booklet style envelope with either an inside pocket affixed on three sides behind a window, or one with separate commercial type envelope affixed to the outside. The proxy envelope is used to mail annual reports along with proxy voting cards to corporate stockholders.
REGULAR:	A term used to describe any commercial envelope that does not have a window.
REMITTANCE ENVELOPE:	A booklet or side seam style envelope with a long wallet type seal flap covering most of the back of the envelope. Used as a collection envelope. Most common sizes being of the commercial and official sizes #6 1/4, #6 3/4, and #9. Boxed with flaps extended.
SAFETY FOLD ENVELOPE:	An open side, center seam envelope with a large wallet flap and a high throat designed to fold over with the flap to increase the security of the contents.
SEAL GUM:	Any adhesive applied to the seal flap of the envelope in order to achieve a seal. See closures.
SEAL FLAP:	The flap that folds down over the envelopes opening in order to seal it.
SHOULDER:	The top edge of the side flaps at the envelope opening.
SIDE FLAPS:	Fold in from the sides to form the sides of the envelope.
SIDE SEAM:	A seam that runs perpendicular to the envelope opening.
SIDE SEAM INSIDE:	The term applied to the side seam when it folds UNDER the bottom flap.
SIDE SEAM OUTSIDE:	The term applied to the side seam when it folds OVER the bottom flap.
SPECIAL:	A very general term used to describe any envelope that is not of a standard size, window position, or paper grade.
STRAIGHT GRAIN CUTTING:	Cutting the blanks for an envelope so the grain of the paper runs parallel to the folds.
SUBSTANCE WEIGHT:	A measure to weight for business papers, utilizing 500 sheets of 17 x 22 paper as the basis for establishing the substance weight of a particular paper.
TABBED:	A counting method for packaged envelopes, which places a paper tab at specified quantities within the box or carton to assist the printer or inserter to select the correct amount of envelopes needed for the operation being performed.
TACKING:	The premature activation of the seal gum at the points where it is over the back seams of an envelope.
THROAT:	The opening at the top of the envelope. The size of the throat is measured from the top edge of the bottom flap to the fold line of the seal flap.
THUMB CUT:	A rounded opening cut through the back, front, or both sides of an envelope opening to facilitate the removal of its contents.

TYVEK:	A synthetic paper made of spunbonded olefin by the DuPont Corp. It is an ultra-lightweight, tear-proof, and water-proof "paper" which when converted into envelopes can accommodate heavy, bulky, and highly confidential mailings. Although Tyvek has countless uses, 14 lb. And 20 lb. Stock is used for envelope converting.
WALLET FLAP:	A type of seal flap that is deep and square in shape.
WEB CUT:	Any envelope manufactured by means of feeding a continuous roll of paper into an envelope machine which cuts the envelope blanks individually with in-line rotary knives. The most common web-cut envelope style is of side seam construction.
WINDOW:	An opening in the envelope with or without a translucent patch designed to allow the contents inside the envelope to show through.

COMMONLY USED ABBREVIATIONS

OSDS	Open side, diagonal seam
OSSS	Open side, side seam
OESSS	Open end, single side seam
SWC	Special window charge
BRE	Business reply envelope
PMS	Pantone matching system
IBM	Any odd size commercial envelope
FCGDB	First class green diamond border
FCM	First class mailer

INDEX

A

- A-style
 - specifications and illustrations32
- air mail
 - specifications and illustrations18
- announcements29-32
- automatic inserting52

B

- baronial sizes29-31
- barcoding48-49
- booklet envelopes,
 - specifications and illustrations20
- bottom flap8-9
- business announcements
 - specifications and illustrations29-30
- business correspondence envelopes17-19

C

- catalog envelopes
 - specifications and illustrations21-23
- center seams10
- clasp,
 - specifications and illustrations12, 33
- closure devices12
- coins
 - specifications and illustrations21
- combination statement and return
 - specifications and illustrations18
- commercial flap11
- commercial
 - specifications and illustrations17

D

- diagonal grain7
- diagonal seams10
- die cutting6-7
- document18
- drive-in bank23
- drug and pay17

E

- embellishment processes37
- embossing37
- envelope basics5-14
 - construction8-9
 - mailability chart50
 - styles15-34
- expansion envelopes24

F

- FASTforward** SM51
- first class mailer20, 22
- filing jackets25
- foil stamping37
- flap styles11
- flexography printing38
- French fold32

G

- grain direction7
- gum8, 9, 12

I

- inside tints39
- interdepartmental envelopes
 - specifications and illustrations23

J

- Jumbo23

L

- laser printing42
- latex seal12
- latex seal catalog
 - specifications and illustrations21
- litho converting40, 41

M

- mailability50
- mailers
 - specifications and illustrations20, 22
- mailpoint flap11
- medical27-28

O

- OCR read area48
- offset printing38
- open end8, 9, 21-23
- open side8, 9, 17-20
- order check list44

P

- paper3, 7
- payroll/jeweler22
- Peel-n-Seel[®]12, 18, 20, 22, 26
- pointed flap11, 30, 31

printing	36-42	T	terminology	53-60
postal requirements	47-51	throat	8, 9	
proxy dual-pack	19	tinted envelopes	39, 41	
proxy bi-pack	19	Two-way remittance		
Q		specifications and illustrations	19	
quality of envelopes	43-46	Tac-n-Tac™		
R		specifications and illustrations	12, 23	
return address area	48	W		
S		wallet flap		
safety fold	26	specifications and illustrations	11, 18	
sample availability	37	window envelopes		
seal adhesive	9, 12	specifications and illustrations	13	
seal flap	8, 9, 11, 12	Z		
sealing methods	12	Zip+4 addressing	50	
seam styles	10			
shipping weights	33-34			
side flaps	8, 9			
side-seams				
specifications and illustrations	9, 10, 17			
Simple-Seal®				
specifications and illustrations	12, 19			
single side seams	9, 10			
social accessories				
size specification charts	29-32			
special purpose envelopes	25-26			
squares				
specifications and illustrations	20			
square flap				
specifications and illustrations	11, 17, 32			
straight grain	7			
String and Button	12, 23			

® Registered Trade Mark of National Envelope Corporation

™ Trade Mark of National Envelope Corporation

• Revised March 2003

NATIONAL SAMPLE DEPARTMENT

800-448-3463

WILLIAMHOUSE SAMPLE DEPARTMENT

800-655-4366